

# IN1124/IN1126

User's Guide  
Mode d'emploi  
Benutzeranleitung  
Manuale d'uso  
Manual de Uso  
Guia do Usuário  
Gebruikershandleiding

Användarhandbok  
Brukerhåndbok  
Руководство по пользователю  
사용 설명서  
用戶指南  
Panduan Pengguna  
دليل المستخدم



Regulatory Model: IN1124/IN1126  
DISPERINDAG No. 0287/1.824.51/09.03

3534194600 

**InFocus**  
Bright Ideas Made Brilliant

## Copyright

This publication, including all photographs, illustrations and software, is protected under international copyright laws, with all rights reserved. Neither this manual, nor any of the material contained herein, may be reproduced without written consent of the author.

© Copyright 2011

## Disclaimer

The information in this document is subject to change without notice. The manufacturer makes no representations or warranties with respect to the contents hereof and specifically disclaims any implied warranties of merchantability or fitness for any particular purpose. The manufacturer reserves the right to revise this publication and to make changes from time to time in the content hereof without obligation of the manufacturer to notify any person of such revision or changes.

## Trademark Recognition

Apple, Macintosh, and PowerBook are trademarks or registered trademarks of Apple Computer, Inc. IBM is a trademark or registered trademark of International Business Machines, Inc. Microsoft, PowerPoint, and Windows are trademarks or registered trademarks of Microsoft Corporation. Adobe and Acrobat are trademarks or registered trademarks of Adobe Systems Incorporated. DLP®, DLP Link and the DLP logo are registered trademarks of Texas Instruments and BrilliantColor™ is a trademark of Texas Instruments. InFocus, In Focus, and INFOCUS (stylized) are either registered trademarks or trademarks of InFocus Corporation in the United States and other countries.



HDMI, the HDMI Logo, and High-Definition Multimedia Interface are trademarks or registered trademarks of HDMI Licensing LLC in the United States and other countries.

All other product names used in this manual are the properties of their respective owners and are acknowledged.

### Important Safety Information

**Important:**

*It is strongly recommended that you read this section carefully before using the projector. These safety and usage instructions will ensure that you enjoy many years of safe use of the projector. Keep this manual for future reference.*

### Symbols Used

Warning symbols are used on the unit and in this manual to alert you of hazardous situations.

The following styles are used in this manual to alert you to important information.

**Note:**

*Provides additional information on the topic at hand.*

**Important:**

*Provides additional information that should not be overlooked.*

**Caution:**

*Alerts you to situations that may damage the unit.*

**Warning:**

*Alerts you to situations that may damage the unit, create a hazardous environment, or cause personal injury.*

Throughout this manual, component parts and items in the On-Screen Display (OSD) menus are denoted in bold font as in this example: "Push the **MENU** button on the remote control to open the **DISPLAY** menu."

### General Safety Information

- Do not open the unit case. Aside from the projection lamp, there are no user-serviceable parts in the unit. For servicing, contact InFocus at [www.infocus.com/support](http://www.infocus.com/support)
- Follow all warnings and cautions in this manual and on the unit case.
- The projection lamp is extremely bright by design. To avoid damage to eyes, do not look into the lens when the lamp is on.
- Do not place the unit on an unstable surface, cart, or stand.
- Avoid using the system near water, in direct sunlight, or near a heating device.
- Do not place heavy objects such as books or bags on the unit.

**Caution:**

*Avoid using the projector in dusty environments.*

**Important:**

*Ventilation openings on the projector allow for good air circulation, which keeps the projector lamp cool. Do not obstruct any of the ventilation openings.*

**Projector Installation Notice**

- Place the projector in a horizontal position  
The tilt angle of the projector should not exceed 15 degrees, nor should the projector be installed in any way other than the desktop and ceiling mount, otherwise lamp life could decrease dramatically.



- Allow at least 50 cm (19.69 inch) clearance around the exhaust vent.

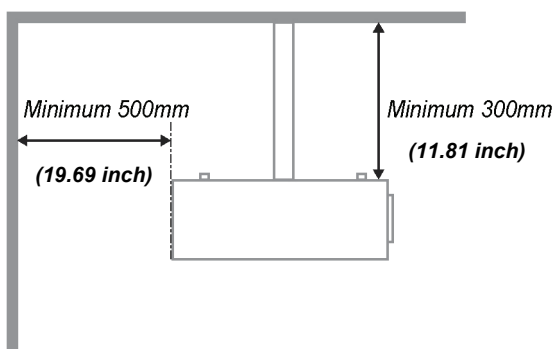
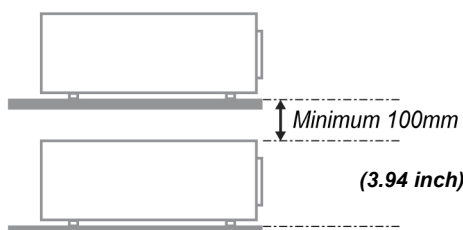
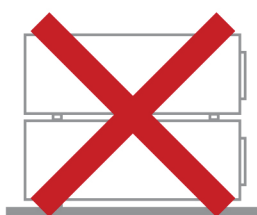
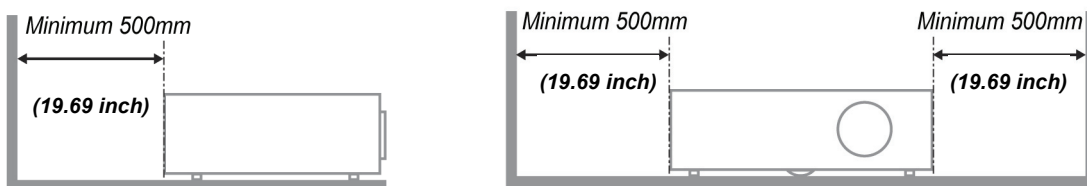

- Ensure that the intake vents do not recycle hot air from the exhaust vent.
- When operating the projector in an enclosed space, ensure that the surrounding air temperature within the enclosure does not exceed 5 – 35°C (41– 95°F) while the projector is running, and the air intake and exhaust vents are unobstructed.
- All enclosures should pass a certified thermal evaluation to ensure that the projector does not recycle exhaust air, as this may cause the device to shutdown even if the enclosure temperature is within the acceptable 5 – 35°C (41– 95°F) range.

**Power Safety**

- Only use the supplied power cord.
- Do not place anything on the power cord. Place the power cord where it will not be in the way of foot traffic.
- Remove the battery from the remote control when storing or not in use for a prolonged period.

### **Replacing the Lamp**

Replacing the lamp can be hazardous if done incorrectly. See *Replacing the Projection Lamp* on page 32 for clear and safe instructions for this procedure. Before replacing the lamp:

- Unplug the power cord.
- Allow the lamp to cool for about one hour.

### **Cleaning the Projector**

- Unplug the power cord before cleaning. See *Cleaning the Projector* on page 34
- Allow the lamp to cool for about one hour.

### **Regulatory Warnings**

Before installing and using the projector, read the regulatory notices in the *Regulatory Compliance* section on page 46.

### **Important Recycle Instructions:**



Lamp(s) inside this product contain mercury. This product may contain other electronic waste that can be hazardous if not disposed of properly. Recycle or dispose in accordance with local, state, or federal laws. For more information, contact the Electronic Industries Alliance at [www.eiae.org](http://www.eiae.org). For lamp specific disposal information check [www.lamprecycle.org](http://www.lamprecycle.org).

### **Symbol Explanations**



DISPOSAL: Do not use household or municipal waste collection services for disposal of electrical and electronic equipment. EU countries require the use of separate recycling collection services.

### **About this Manual**

This manual is intended for end users and describes how to install and operate the DLP projector. Whenever possible, relevant information—such as an illustration and its description—has been kept on one page. This printer-friendly format is both for your convenience and to help save paper, thereby protecting the environment. It is suggested that you only print sections that are relevant to your needs.

## Table of Contents

<b>GETTING STARTED</b> .....	<b>1</b>
PACKING CHECKLIST .....	1
VIEWS OF PROJECTOR PARTS.....	2
<i>Front-angled View</i> .....	2
<i>Top view—Keypad buttons</i> .....	3
<i>Rear view</i> .....	4
<i>Bottom view</i> .....	5
REMOTE CONTROL PARTS .....	6
REMOTE CONTROL OPERATING RANGE .....	7
PROJECTOR AND REMOTE CONTROL BUTTONS.....	7
<i>Remote Control</i> .....	7
<b>SETUP AND OPERATION</b> .....	<b>8</b>
INSERTING THE REMOTE CONTROL BATTERY (BATTERY NOT INCLUDED).....	8
STARTING AND SHUTTING DOWN THE PROJECTOR .....	9
SETTING AN ACCESS PASSWORD (SECURITY LOCK).....	11
ADJUSTING THE PROJECTOR LEVEL .....	13
ADJUSTING ZOOM, FOCUS AND KEYSTONE .....	14
ADJUSTING THE VOLUME .....	15
ADJUSTING DIGITAL ZOOM.....	15
<b>ON-SCREEN DISPLAY (OSD) MENU SETTINGS</b> .....	<b>16</b>
OSD MENU CONTROLS .....	16
<i>Navigating the OSD</i> .....	16
SETTING THE OSD LANGUAGE.....	17
OSD MENU OVERVIEW.....	18
OSD SUB-MENU OVERVIEW .....	19
IMAGE MENU .....	20
<i>Advanced Features</i> .....	21
<i>Color Manager</i> .....	22
COMPUTER MENU .....	23
VIDEO/AUDIO MENU .....	24
<i>Audio</i> .....	25
INSTALLATION I MENU.....	26
<i>Advanced</i> .....	27
INSTALLATION II MENU.....	28
<i>Advanced Features</i> .....	29
<i>Status</i> .....	31
<b>MAINTENANCE AND SECURITY</b> .....	<b>32</b>
REPLACING THE PROJECTION LAMP .....	32
CLEANING THE PROJECTOR .....	34
<i>Cleaning the Lens</i> .....	34
<i>Cleaning the Case</i> .....	34
USING THE SECURITY LOCK .....	35
<b>TROUBLESHOOTING</b> .....	<b>36</b>
COMMON PROBLEMS AND SOLUTIONS .....	36
TIPS FOR TROUBLESHOOTING .....	36
LED ERROR MESSAGES .....	37
IMAGE PROBLEMS .....	37
LAMP PROBLEMS.....	38
REMOTE CONTROL PROBLEMS.....	38
AUDIO PROBLEMS .....	39
HAVING THE PROJECTOR SERVICED .....	39
HDMI Q & A.....	40

**SPECIFICATIONS** ..... 41

    SPECIFICATIONS .....41

    PROJECTION DISTANCE VS. PROJECTION SIZE .....42

    TIMING MODE TABLE .....43

    PROJECTOR DIMENSIONS .....45

**REGULATORY COMPLIANCE**..... 46

    FCC WARNING .....46

    CANADA.....46

    WEEE.....46

    SAFETY CERTIFICATIONS .....46

## GETTING STARTED

### Packing Checklist

Carefully unpack the projector and check that the following items are included:

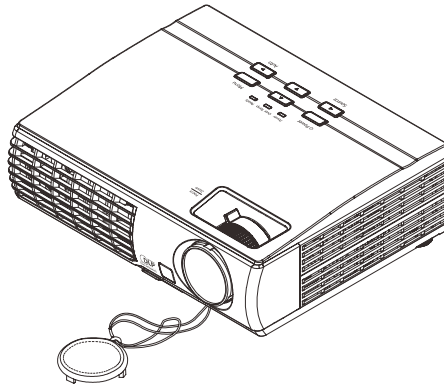

*DLP PROJECTOR*

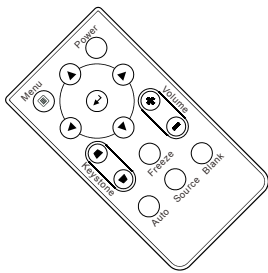

*REMOTE CONTROL  
(BATTERY NOT INCLUDED)*



*CD-ROM  
(THIS USER'S MANUAL)*

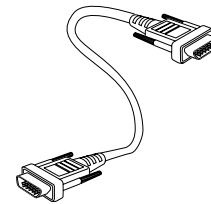

*VGA CABLE*

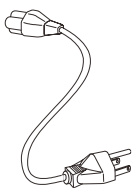

*POWER CORD  
(VARIES PER COUNTRY)*



*SAFETY/WARRANTY  
BOOKLET*



*QUICK START GUIDE*

Contact your dealer immediately if any items are missing, appear damaged, or if the unit does not work. It is recommended that you keep the original packing material in case you ever need to return the equipment for warranty service.



Views of Projector Parts

Front-angled View

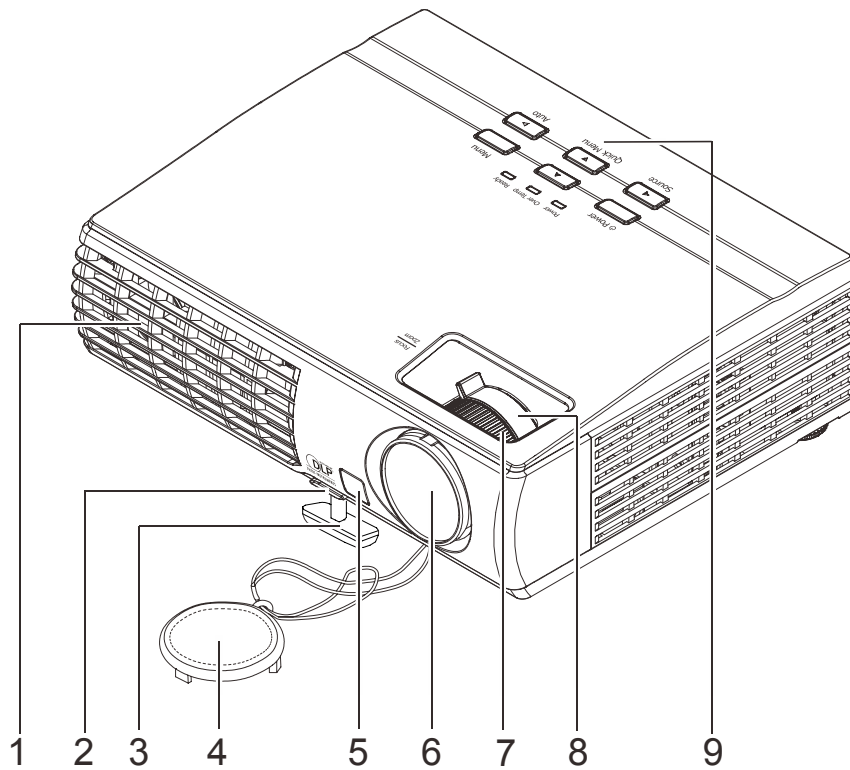

ITEM	LABEL	DESCRIPTION	SEE PAGE:
1.	Ventilation opening	Do not block this vent. Blocking the vent can cause the projector to overheat	
2.	Elevator foot button	Push to release the elevator foot	13
3.	Elevator foot	Adjusts the height of projector	
4.	Lens cap	Used to protect the lens when the projector is not in use	
5.	IR receiver	Receives the IR signals from the remote control	6
6.	Lens	Projection Lens	
7.	Focus ring	Focuses the projected image	14
8.	Zoom ring	Enlarges the projected image	
9.	Keypad buttons	See Top view—Keypad buttons.	3

**Important:**

Ventilation openings on the projector allow for good air circulation, which keeps the projector lamp cool. Do not obstruct any of the ventilation openings.

Top view—Keypad buttons

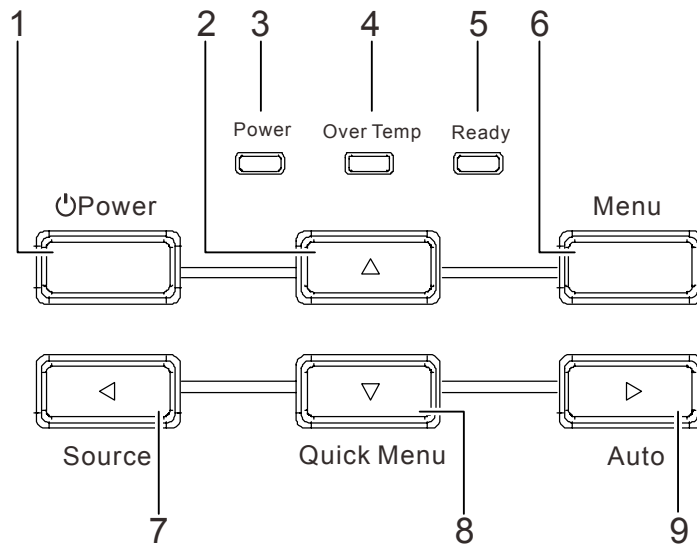

ITEM	LABEL	DESCRIPTION		SEE PAGE:
1.	(Power)	Turns the projector on and off		
2.	▲ (Up cursor)	Navigates through the OSD menu		<b>16</b>
3.	Power LED	Green	Power On	
		Off	Power Off (AC Off)	
		Flashing	Error code (see <i>LED Error Messages</i> on page 37 )	
4.	Over Temp LED	On	System over temperature	
		Off	Normal State	
5.	Ready LED	Orange	Lamp is ready to be powered-on.	
		Flashing	Lamp is not ready (Warm-up/shutting down/cooling) (see <i>LED Error Messages</i> on page 37)	
6.	Menu	Displays and closes the OSD menu		
7.	◀ (Left cursor)/ Source	Opens up the Source submenu Navigates and changes settings in the OSD menu		<b>16</b>
8.	▼ (Down cursor) / Quick Menu	Quick Menu – For Keystone, Audio Volume and Digital Zoom Navigates through the OSD menu		<b>14, 15, 16</b>
9.	▶ (Right cursor)/ Auto	Optimizes image size, position, and resolution Navigates and changes settings in the OSD menu		<b>16</b>

Rear view

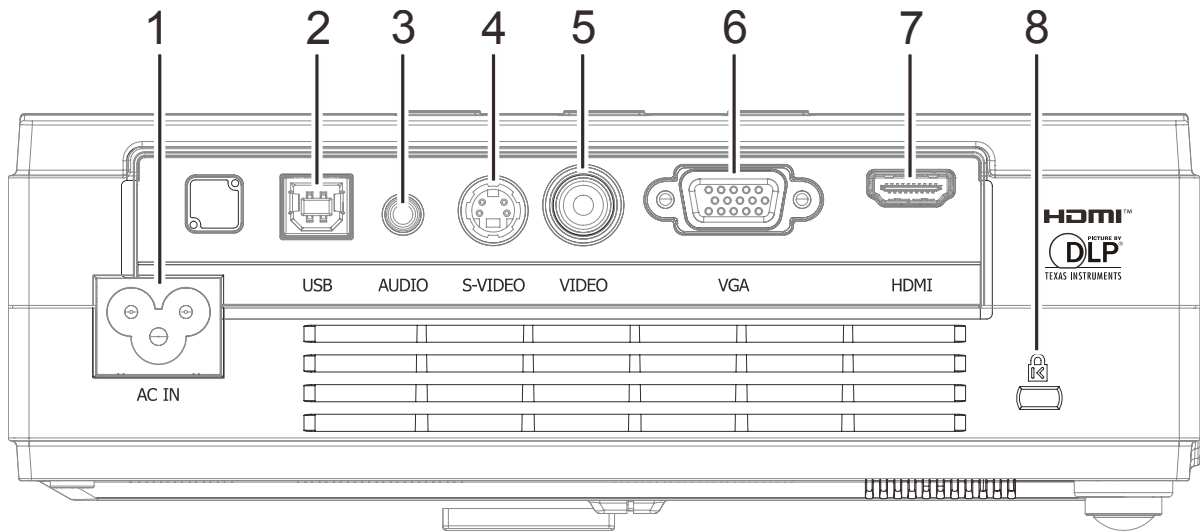

ITEM	LABEL	DESCRIPTION	SEE PAGE:
1.	AC IN	AC Power input 100~240VAC	9
2.	USB	For Service only	
3.	AUDIO	Stereo Audio input	
4.	S-VIDEO	S-video source input	
5.	VIDEO	Composite video source input	
6.	VGA	Computer video source input	
7.	HDMI	HDMI video source input	
8.	Security Lock	Connect a security lock system to the projector and attach to a permanent object	35

**Note:**

*If your video equipment has various video source inputs, it is recommended that you connect to the video source input which will provide the best image quality. The following list is in order of best quality to acceptable quality: HDMI, VGA, S-video and composite.*

**Warning:**

*As a safety precaution, disconnect all power to the projector and connecting devices before making connections.*

Bottom view

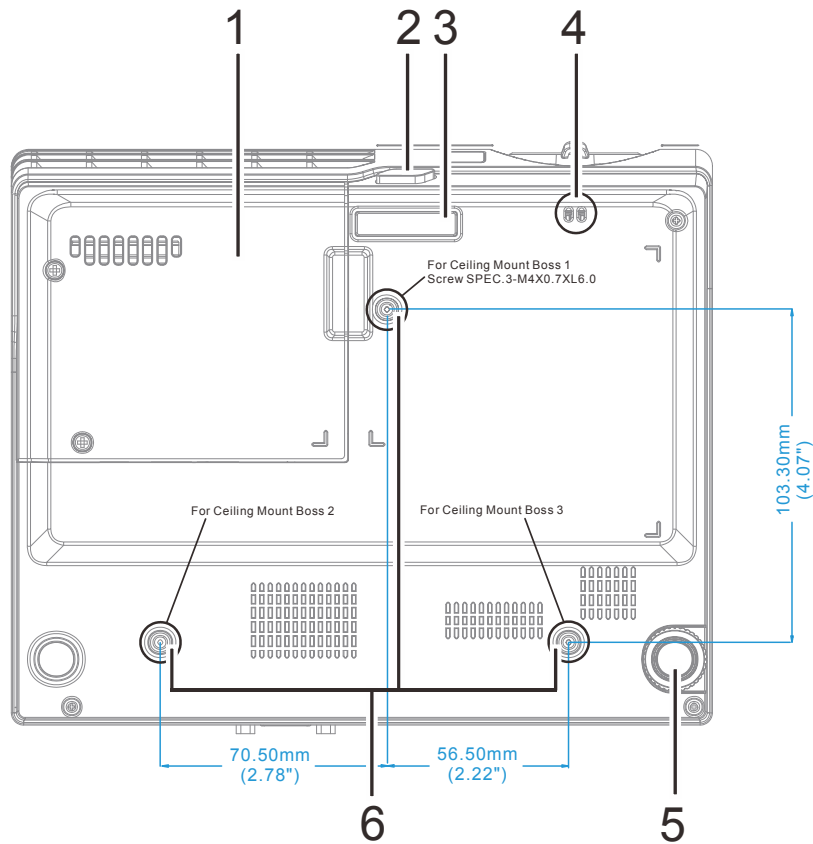

ITEM	LABEL	DESCRIPTION	SEE PAGE:
1.	Lamp cover	Remove when changing the lamp.	32
2.	Elevator foot button	Push to release the elevator foot.	13
3.	Elevator foot	Use to adjust the height of the projector	
4.	Lens cap hook	To fasten the lens cap cover.	
5.	Leveling foot	Rotate the leveling foot to adjust angle position.	13
6.	Ceiling support holes	Only use with an InFocus ceiling mount system (p/n PRJ-MNT-UNIV). See your InFocus dealer or go to <a href="http://www.infocusstore.com">www.infocusstore.com</a> .	

**Note:**

*When installing, ensure that you use only UL Listed ceiling mounts.*

*For ceiling installations, use approved mounting hardware and M4 screws with a maximum screw depth of 6 mm (0.23 inch).*

*The construction of the ceiling mount must be of a suitable shape and strength. The ceiling mount load capacity must exceed the weight of the installed equipment, and as an additional precaution be capable of withstanding three times the weight of the equipment over a period of 60 seconds.*

Remote Control Parts

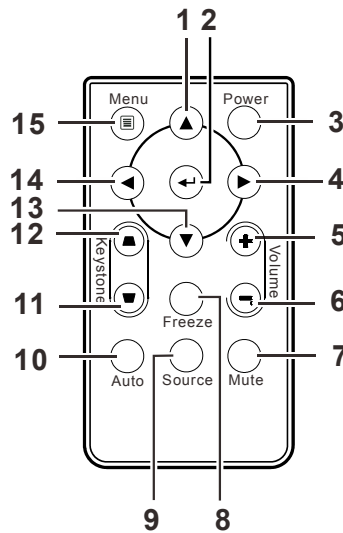

ITEM	LABEL	DESCRIPTION	SEE PAGE:
1.	Up cursor	Navigates through the OSD menu	<b>16</b>
2.	Enter	Changes settings in the OSD menu	
3.	Power	Turns the projector on and off	<b>9</b>
4.	Right cursor	Navigates and changes settings in the OSD menu	<b>16</b>
5.	Volume+	Increases the volume	<b>15</b>
6.	Volume-	Decreases the volume	
7.	Mute	Hold <2 seconds: Mutes the Audio Hold >2 seconds: Mutes the Audio and Blanks the Screen	
8.	Freeze	Freezes the video	
9.	Source	Opens up the Source submenu	
10.	Auto	Automatically adjusts frequency, tracking, size and position (RGB only)	
11.	Keystone top	Corrects trapezoid images which are wider at the top.	<b>14</b>
12.	Keystone bottom	Corrects trapezoid images which are wider at the bottom.	
13.	Down cursor	Navigates through the OSD menu	<b>16</b>
14.	Left cursor	Navigates and changes settings in the OSD menu	
15.	Menu	Displays and closes the OSD menu	

**Important:**

1. Avoid using the projector with bright fluorescent lighting turned on. Certain high-frequency fluorescent lights can disrupt remote control operation.
2. Be sure nothing obstructs the path between the remote control and the projector. If the path between the remote control and the projector is obstructed, you can bounce the signal off certain reflective surfaces such as projector screens.
3. The buttons and keys on the projector have the same functions as the corresponding buttons on the remote control. This user's manual describes the functions based on the remote control.

## Remote Control Operating Range

The remote control uses infrared transmissions to control the projector. It is not necessary to point the remote directly at the projector. Provided you are not holding the remote perpendicular to the sides or the rear of the projector, the remote will function well within a radius of about 7 meters (23 feet) and 15 degrees above or below the projector level. If the projector does not respond to the remote control, move a little closer to the projector.

## Projector and Remote Control Buttons

The projector can be operated using the remote control or the projector keypad buttons. All operations can be carried out with the remote control; however, the buttons on the projector are limited in use. The following illustration shows the corresponding buttons on the remote control and on the projector.

### Remote Control

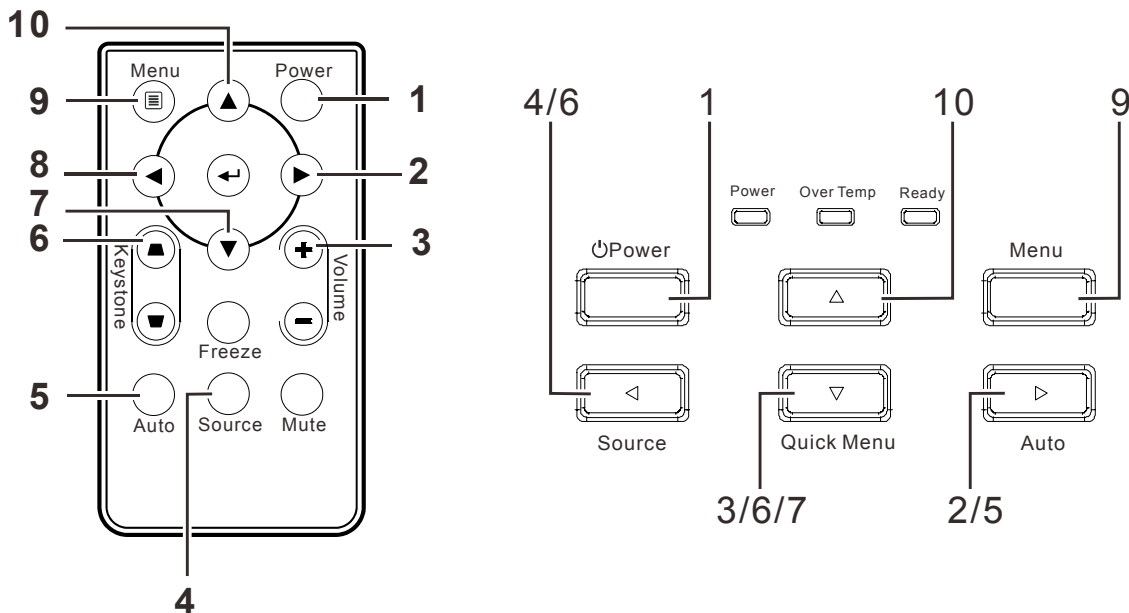

Some buttons on the projector have multiple functions. For example, the Quick Menu button on the projector functions as the Keystone button (6), Volume control (3) and the Down cursor key (7).

### Inserting the Remote Control Battery (battery not included)

1. Remove the battery compartment cover by sliding the cover in the direction of the arrow (A). Pull out the cover (B).

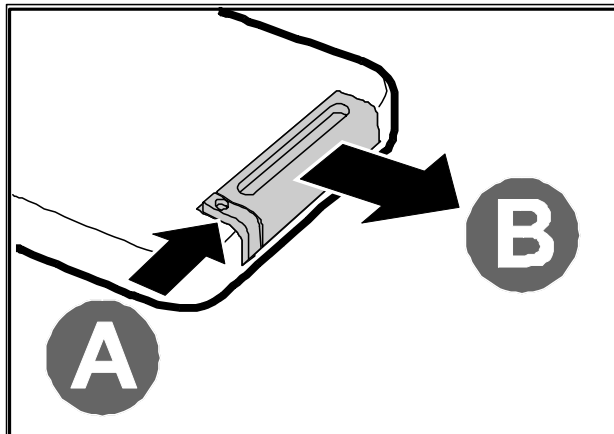

2. Insert a 3V CR2025 battery (not included) with the positive side facing up.

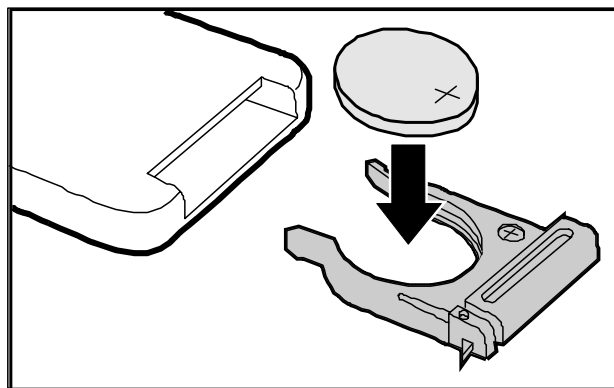

3. Replace the cover.

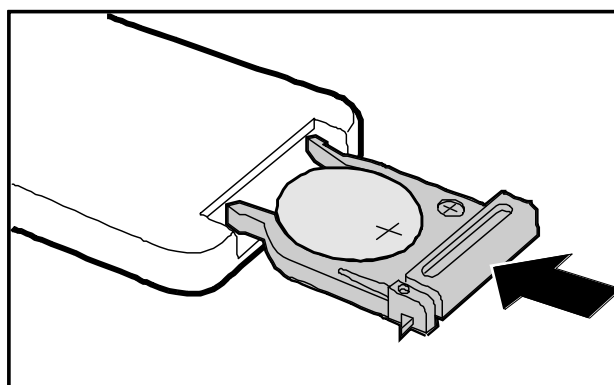



**Caution:**

1. Only use CR2025 battery.
2. Dispose of used batteries according to local ordinance regulations.
3. Remove the battery when the projector is not being used for prolonged periods.

## Starting and Shutting down the Projector

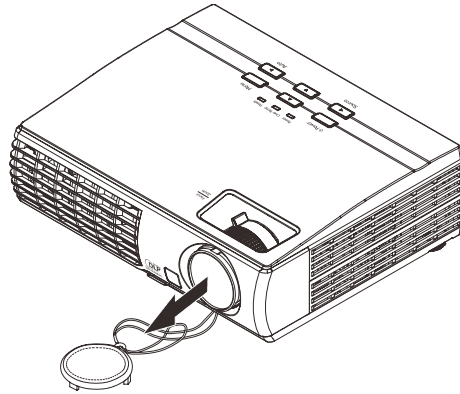

1. Remove the lens cap.

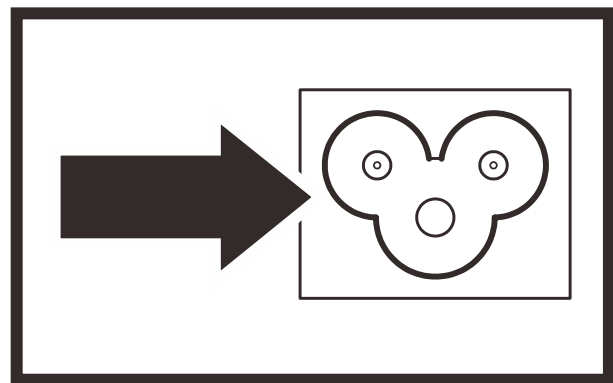

2. Connect the power cord to the projector. Connect the other end to a wall outlet.  
The  **Power** and **Ready** LEDs on the projector light.



3. Turn on the connected devices.

4. Ensure the  **Power** LED displays a solid green and not flashing green; **Ready** LED displays a solid orange.  
Then press the  **Power** button to turn on the projector.

The projector splash screen displays and connected devices are detected.

See *Setting an Access Password (Security Lock)* on page 11 if Security Lock is enabled.





- 5.** If more than one input device is connected, press the **SOURCE** button and use ▲▼ to scroll among devices.



- VGA : Analog RGB  
Component: DVD input YCbCr / YPbPr, or HDTV input YPbPr via HD15 connector
- Composite Video: Traditional composite video
- S-Video: Super video (Y/C separated)
- HDMI : High Definition Multimedia Interface

- 6.** To turn the projector off, press the Power OFF button on the remote. When the "Power Off? / Press **Power** again" message appears, press the **POWER** button again. The projector turns off.

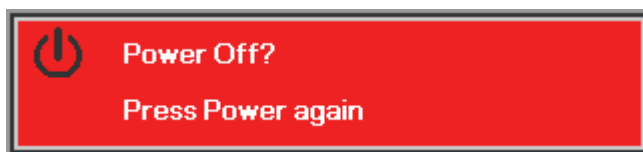

**Caution:**

1. Be sure to remove the lens cap before starting projector.
2. Do not unplug the power cord until the READY LED stops flashing—indicating the projector has cooled down.

## Setting an Access Password (Security Lock)

You can use the four (arrow) buttons to set a password and prevent unauthorized use of the projector. When enabled, the password must be entered after you power on the projector. (See *Navigating the OSD* on page 16 and *Setting the OSD Language* on page 17 for help on using OSD menus)

**Important:**

Keep the password in a safe place. Without the password, you will not be able to use the projector. If you lose the password, contact InFocus at [www.infocus.com/support](http://www.infocus.com/support).

1. Press the **MENU** button to open the OSD menu.

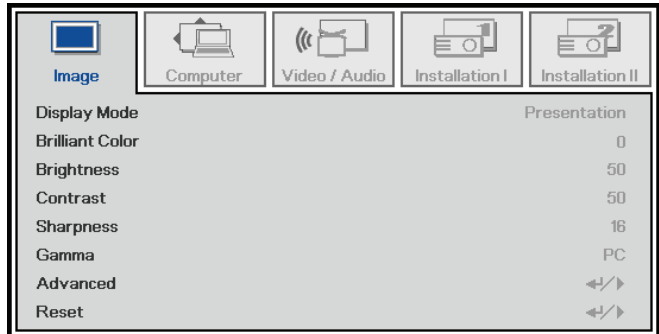

2. Press the cursor ◀▶ button to move to the **Installation I** menu. Press the cursor ▲▼ button to highlight **Advanced**. Press the Select button or right arrow button to select the Advanced menu.

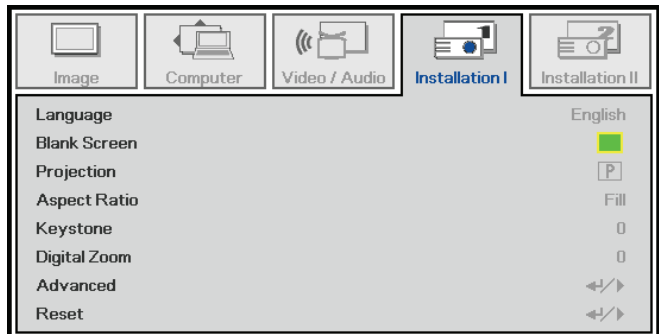

3. Press the cursor ▲▼ button to select **Security Lock**.

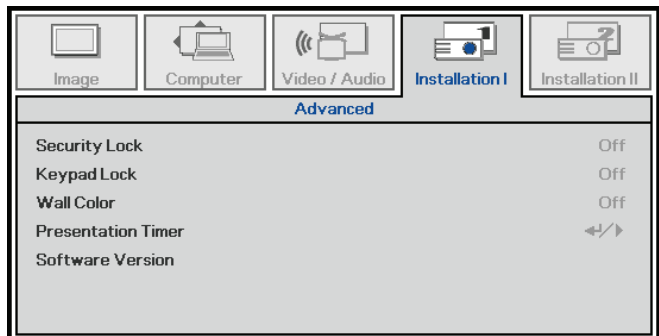

4. Press the cursor ◀▶ button to enable or disable security lock function.

A password dialog box automatically appears.

5. Use the arrow buttons ▲▼◀▶ on either the keypad or remote control to enter a password. Any combination can be used, including the same arrow button, but you must use a combination of five arrow button presses.

Push the **MENU** button to exit the dialog box.

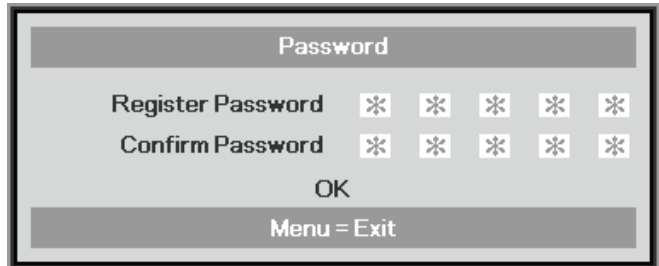
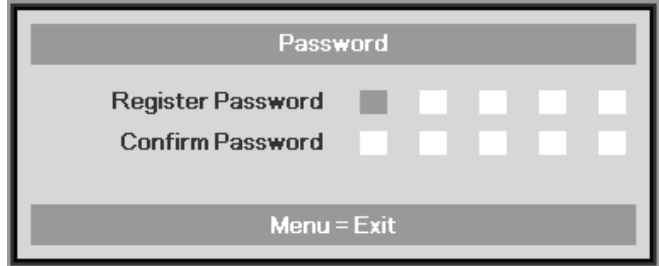

6. The password confirm menu appears when the user powers on the projector and the Security Lock feature is enabled. Enter the password you set during step 5. In case you forget the password, please contact InFocus at [www.infocus.com/support](http://www.infocus.com/support). The service center will validate the owner and help reset the password.

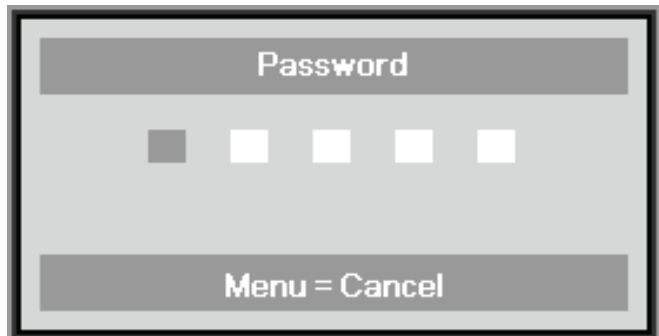

## Adjusting the Projector Level

When setting up the projector:

- *The projector table or stand should be level and sturdy.*
- *Position the projector so that it is perpendicular to the screen.*
- *Ensure the cables are in a safe location. You could trip over them.*

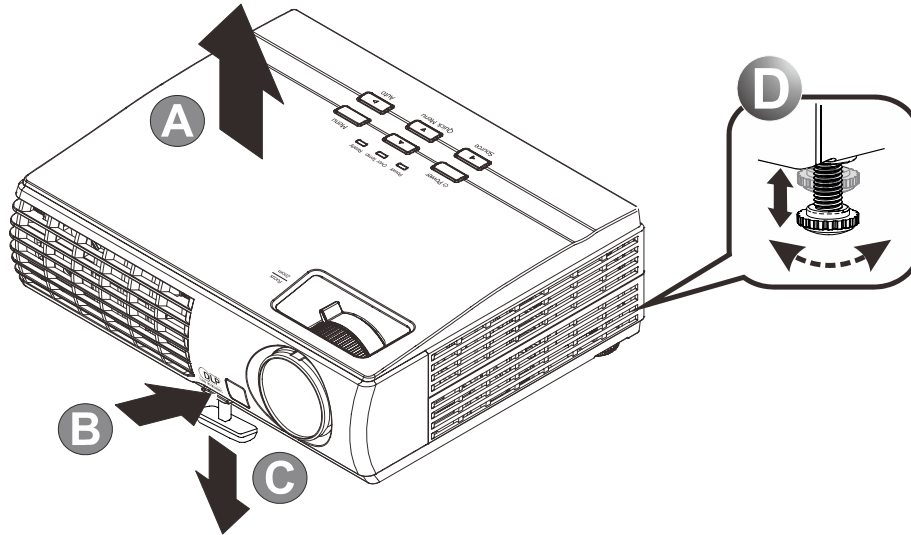

- 1.** To raise the level of the projector, lift the projector **[A]** and press the Elevator foot button **[B]**.  
The Elevator foot drops down **[C]**.
- 2.** To lower the level of the projector, press the Elevator foot button and push down on the top of the projector.
- 3.** To adjust the angle of the picture, turn the Leveling foot **[D]** right or left until the desired angle has been achieved.

## Adjusting Zoom, Focus and Keystone

1. Use the **Image-zoom** control (on the projector only) to resize the projected image and screen size **B**.

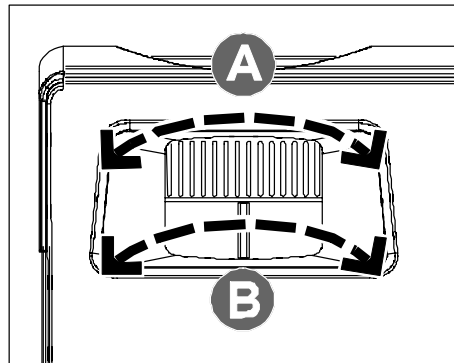

2. Use the **Image-focus** control (on the projector only) to sharpen the projected image **A**.

3. Use the **Quick Menu** button on the projector or **Keystone** on the remote control to correct trapezoid images which are wider on the top or bottom.

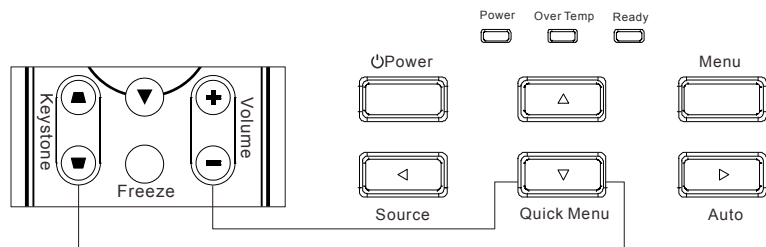

Remote control and OSD panel

4. The keystone control appears on the display.



5. Press ◀ or ▶ to adjust keystone.

**Note:**

When the OSD menu is off, the **Quick Menu** button will cycle through Volume, Keystone, and Digital Zoom adjustments.

## Adjusting the Volume

1. Press the **Volume +/-** buttons on the remote control or press the **Quick Menu** button on the keypad until the Volume OSD appears on the display.

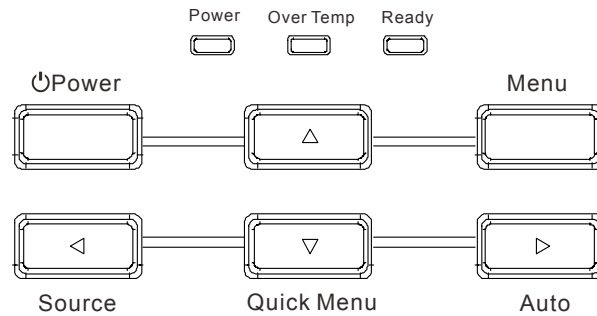
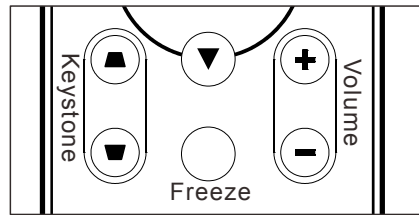

2. Press ◀ or ▶ to adjust volume.



3. Press the **MUTE** button to turn off the audio (This feature is only available on the remote).



## Adjusting Digital Zoom

1. Press the **Quick Menu** button on the keypad until the Digital Zoom OSD appears on the display.



2. Press ◀ or ▶ to zoom the image in or out.

## ON-SCREEN DISPLAY (OSD) MENU SETTINGS

### OSD Menu Controls

The projector has an OSD that lets you make image adjustments and change various settings.

#### Navigating the OSD

You can use the remote control cursor buttons or the buttons on the top of the projector to navigate and make changes to the OSD. The following illustration shows the corresponding buttons on the remote control and on the projector.

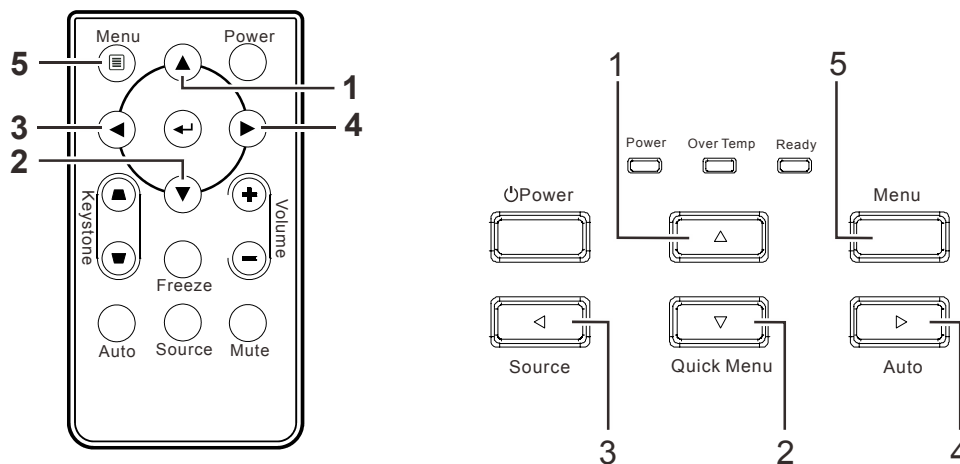

1. To enter the OSD, press the **MENU** button.
2. There are five menus. Press the cursor ◀▶ button to move through the menus.
3. Press the cursor ▲▼ button to move up and down in a menu.
4. Press ◀▶ to change setting values.
5. Press **MENU** to close the OSD or leave a sub menu.

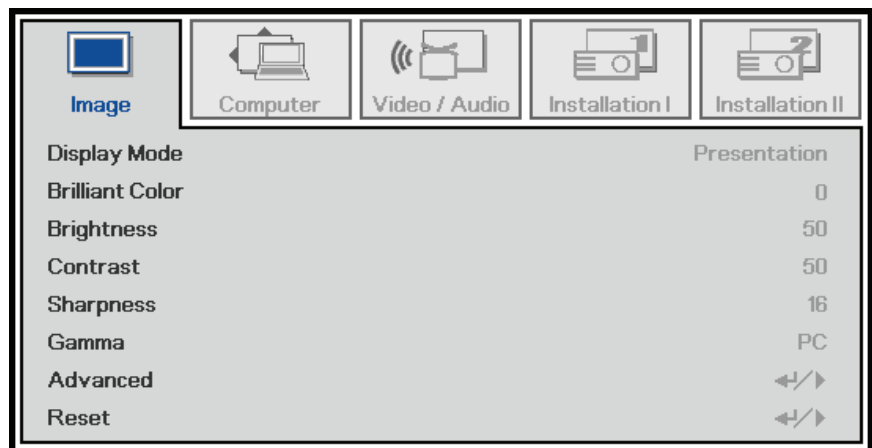

**Note:**

Depending on the video source, not all items in the OSD are available. For example, the **Horizontal/Vertical Position** items in the **Computer** menu can only be modified when connected to a PC. Items that are not available cannot be accessed and are grayed out.

## Setting the OSD Language

Set the OSD language to your preference before continuing.

1. Press the **MENU** button. Press the cursor ◀▶ button to navigate to **Installation I**.

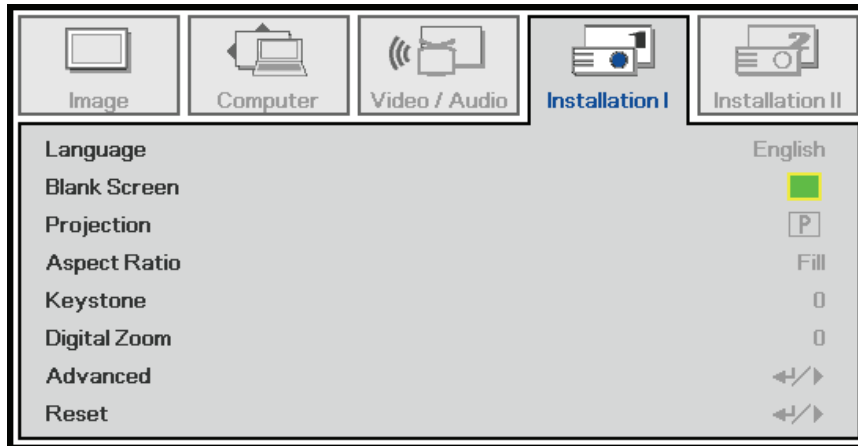

2. Press the cursor ▲▼ button until **Language** is highlighted.
3. Press the cursor ◀▶ button until the language you want is selected.
4. Press the **MENU** button to close the OSD.



## OSD Menu Overview

Use the following illustration to quickly find a setting or determine the range for a setting.

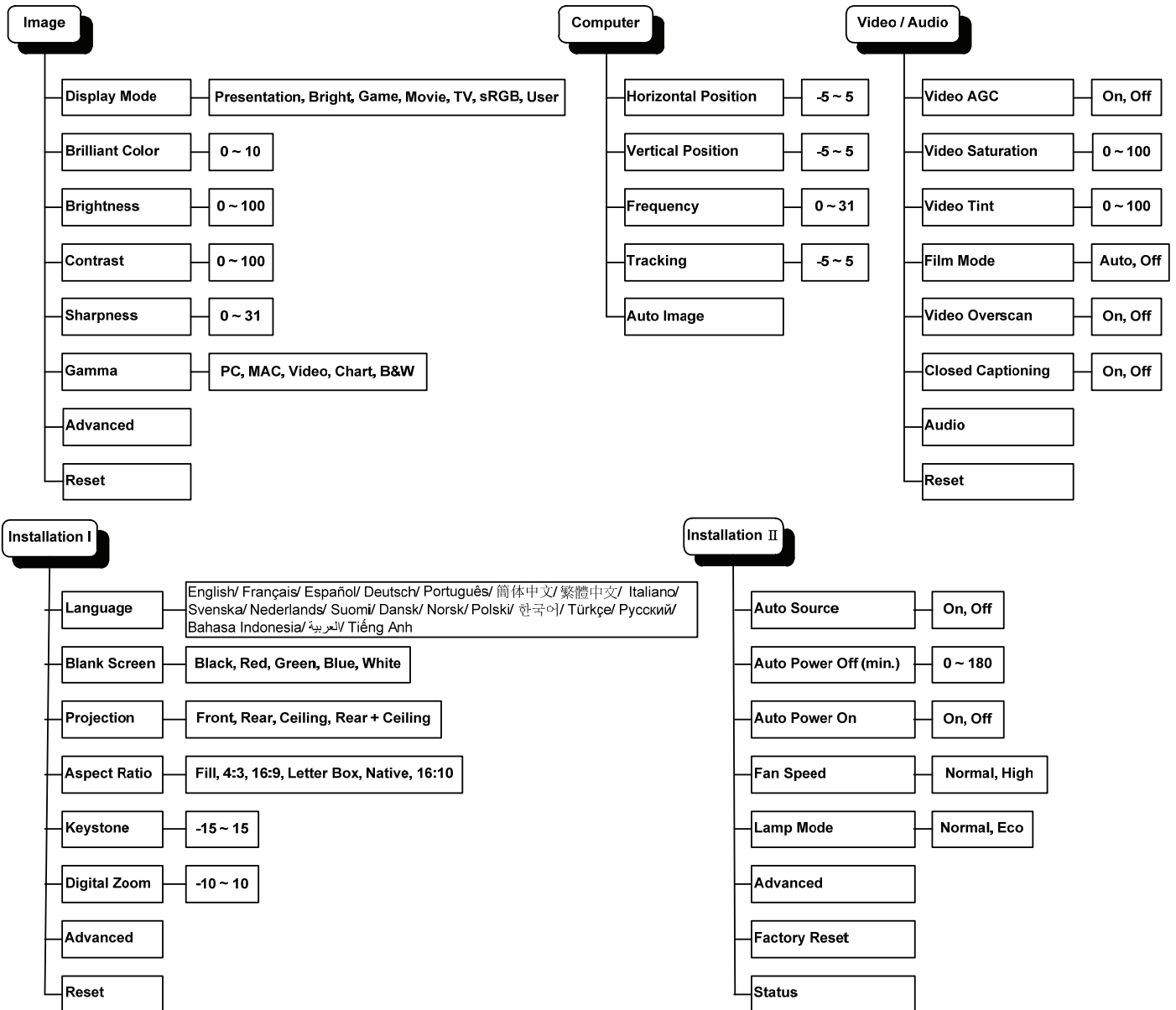

## OSD Sub-Menu Overview

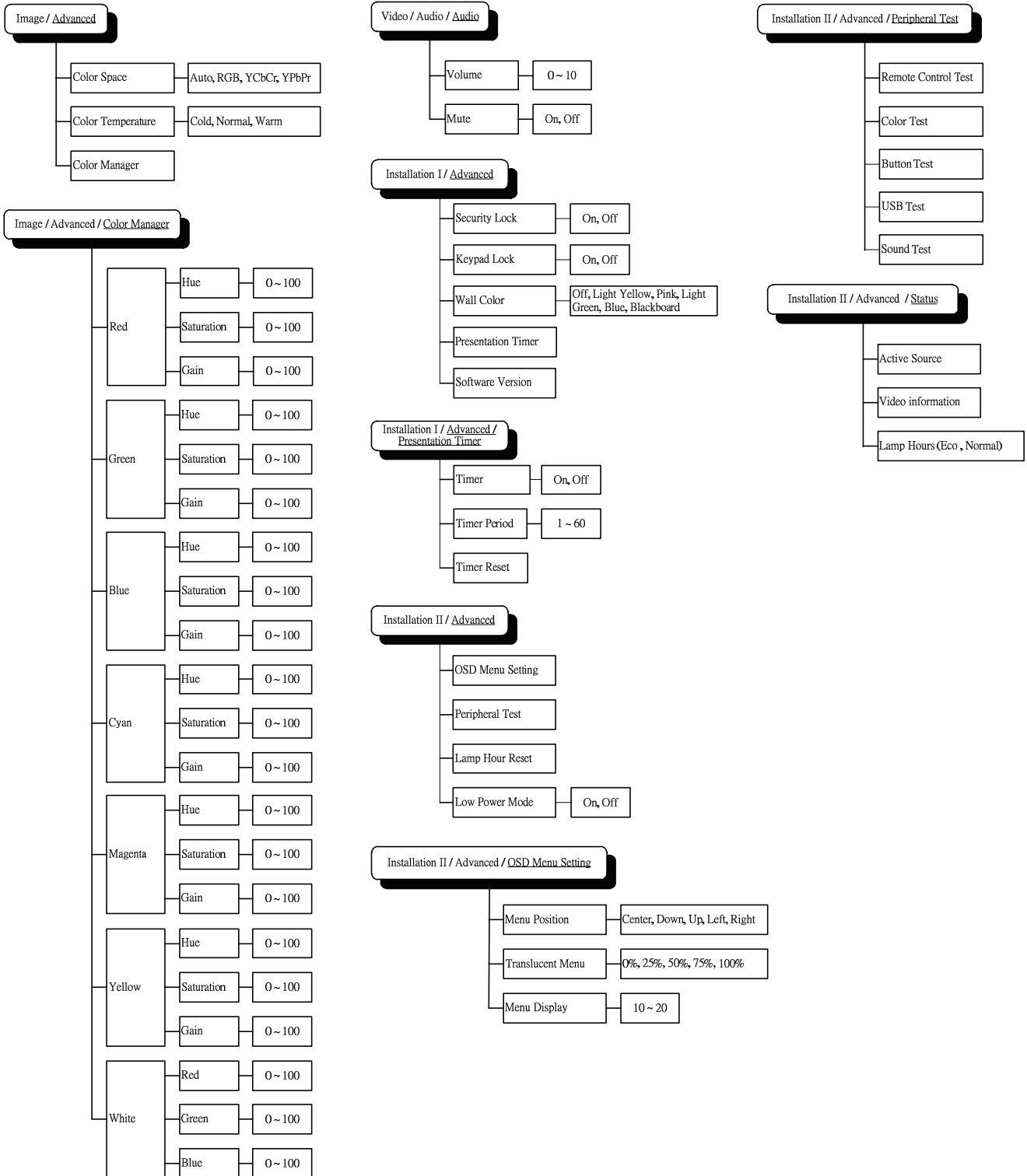

## Image Menu

Press the **MENU** button to open the **OSD** menu. Press the cursor ◀▶ button to move to the **Image Menu**. Press the cursor ▲▼ button to move up and down in the **Image** menu. Press ◀▶ to change setting values.

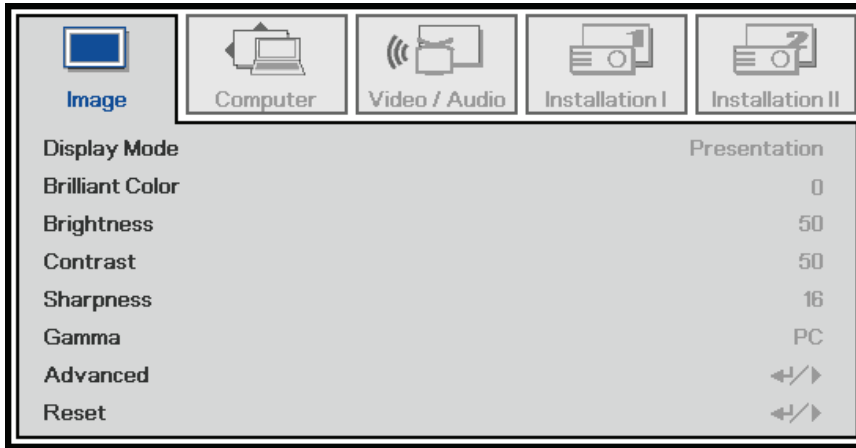

ITEM	DESCRIPTION
Display Mode	Press the cursor ◀▶ button to set the Display Mode.
Brilliant Color	Press the cursor ◀▶ button to adjust the Brilliant Color value.
Brightness	Press the cursor ◀▶ button to adjust the display brightness.
Contrast	Press the cursor ◀▶ button to adjust the display contrast.
Sharpness	Press the cursor ◀▶ button to adjust the display sharpness level.
Gamma	Press the cursor ◀▶ button to adjust the gamma correction of the display.
Advanced	Press ◀ (Enter) / ▶ to enter the Advanced menu. See <i>Advanced Features</i> on page 21.
Reset	Press ◀ (Enter) / ▶ to reset all settings to default values.

Advanced Features

Press the **Menu** button to open the **OSD** menu. Press ◀▶ to move to the **Image** menu. Press ▼▲ to move to the **Advanced** menu and then press **Enter** or ▶. Press ▼▲ to move up and down in the **Advanced** menu.

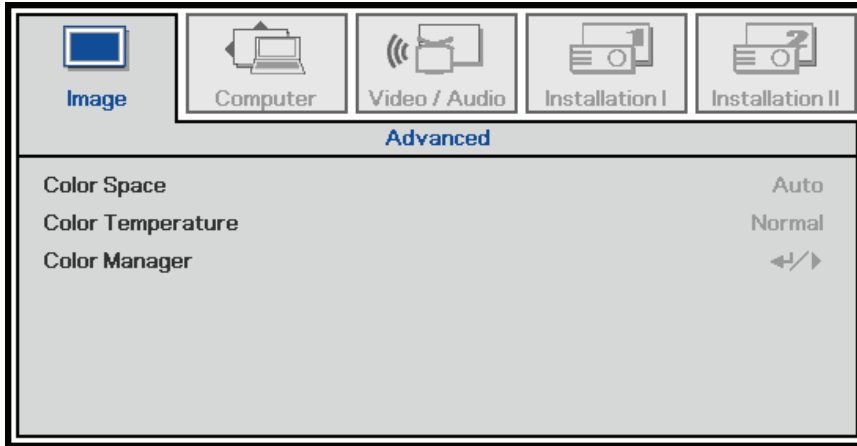

ITEM	DESCRIPTION
Color Space	Press the cursor ◀▶ button to adjust the color space.
Color Temperature	Press the cursor ◀▶ button to adjust the color temperature.
Color Manager	Press ◀ (Enter) / ▶ to enter the Color Manager menu. See page 22 for more information on <i>Color Manager</i> .

Color Manager

Press ◀ (Enter) / ▶ to enter the **Color Manager** sub menu.

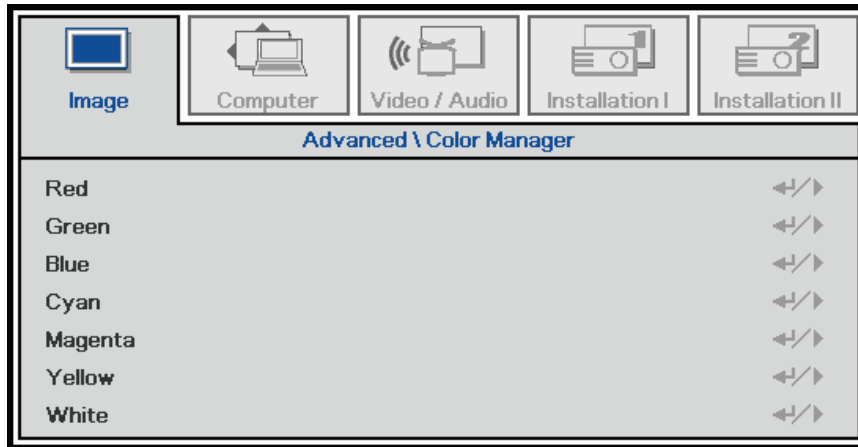

ITEM	DESCRIPTION
Red	Select to enter the Red Color Manager. Press the ◀▶ buttons to adjust the Hue, Saturation, and Gain.
Green	Select to enter the Green Color Manager. Press the ◀▶ buttons to adjust the Hue, Saturation, and Gain.
Blue	Select to enter the Blue Color Manager. Press the ◀▶ buttons to adjust the Hue, Saturation, and Gain.
Cyan	Select to enter the Cyan Color Manager. Press the ◀▶ buttons to adjust the Hue, Saturation, and Gain.
Magenta	Select to enter the Magenta Color Manager. Press the ◀▶ buttons to adjust the Hue, Saturation, and Gain.
Yellow	Select to enter the Yellow Color Manager. Press the ◀▶ buttons to adjust the Hue, Saturation, and Gain.
White	Select to enter the White Color Manager. Press the ◀▶ buttons to adjust the Red, Green, and Blue.

## Computer Menu

Press the **MENU** button to open the **OSD** menu. Press the cursor ◀▶ button to move to the **Computer** menu. Press the cursor ▲▼ button to move up and down in the computer menu. Press ◀▶ to change setting values.

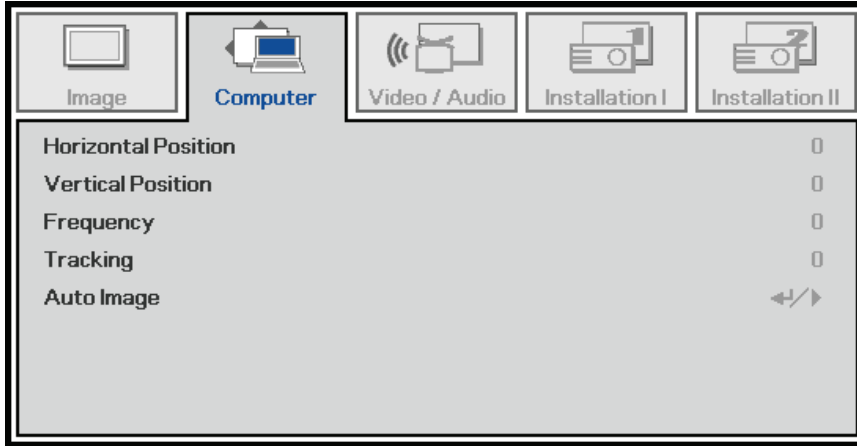

ITEM	DESCRIPTION
Horizontal Position	Press the cursor ◀▶ button to adjust the display position left or right.
Vertical Position	Press the cursor ◀▶ button to adjust the display position up or down.
Frequency	Press the cursor ◀▶ button to adjust the A/D sampling clock.
Tracking	Press the cursor ◀▶ button to adjust the A/D sampling dot.
Auto Image	Press ◀ (Enter) / ▶ to automatically adjustment for phase, tracking, size and position.

## Video/Audio Menu

Press the **MENU** button to open the **OSD** menu. Press the cursor ◀▶ button to move to the **Video/Audio** menu. Press the cursor ▲▼ button to move up and down in the **Video/Audio** menu. Press ◀▶ to change setting values.

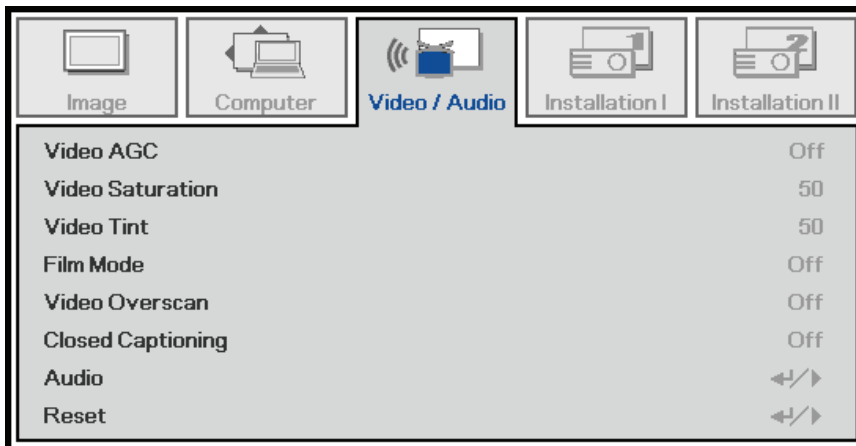

ITEM	DESCRIPTION
Video AGC	Press the ◀▶ buttons to enable or disable the Automatic Gain Control for video source.
Video Saturation	Press the ◀▶ buttons to adjust the video saturation.
Video Tint	Press the ◀▶ buttons to adjust the video tint/hue.
Film Mode	Press the ◀▶ buttons to select a different film mode.
Video Overscan	Press the ◀▶ buttons to enable or disable Video Overscan.
Closed Captioning	Press the ◀▶ buttons to enable or disable Closed Captioning.
Audio	Press ⏏ (Enter) / ▶ to enter the Audio menu. See <i>Audio</i> on page 25.
Reset	Press ⏏ (Enter) / ▶ to reset all settings to default values.

**Note:**

*Video jaggging may occur when playing interlaced video. To overcome this issue, open the Video / Audio menu and adjust the Film Mode feature.*

Audio

Press ◀ (Enter) / ▶ to enter the **Audio** sub menu.

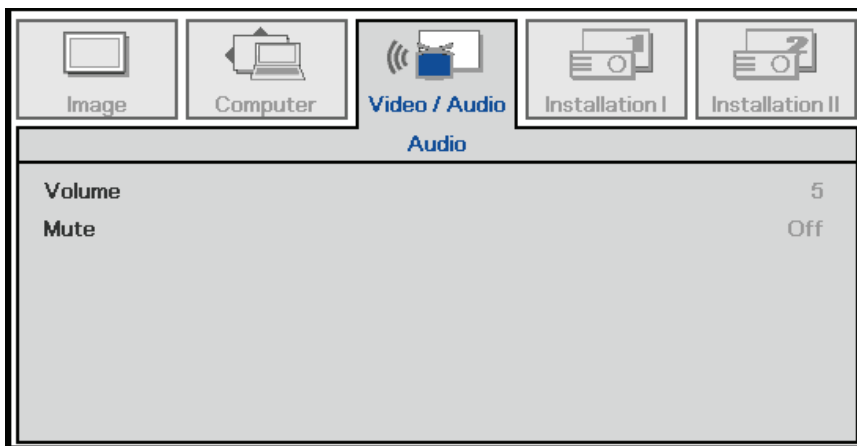

ITEM	DESCRIPTION
Volume	Press the ◀▶ buttons to adjust the audio volume.
Mute	Press the ◀▶ buttons to turn the speaker on or off.



## Installation I Menu

Press the **MENU** button to open the **OSD** menu. Press the cursor ◀▶ button to move to the **Installation I** menu. Press the cursor ▲▼ button to move up and down in the **Installation I** menu. Press ◀▶ to change setting values.

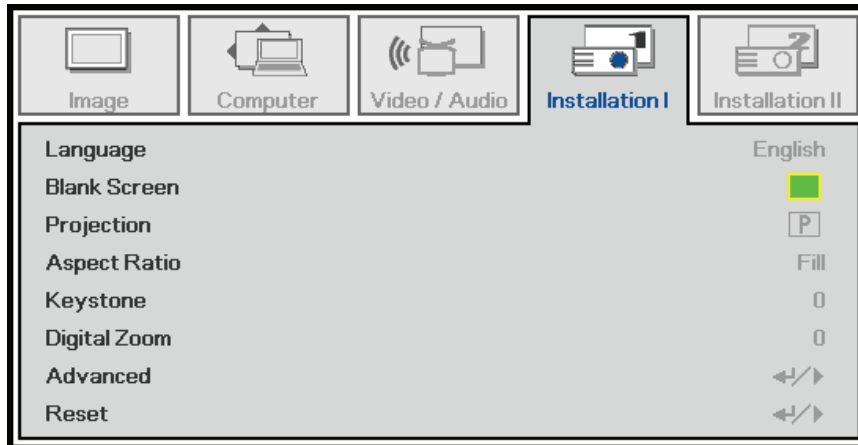

ITEM	DESCRIPTION
Language	Press the cursor ◀▶ buttons to select a different localized menu. (Range: English/ Français/ Español/ Deutsch/ Português/ 简体中文/ 繁體中文/ Italiano/ Svenska/ Nederlands/ Suomi/ Dansk/ Norsk/ Polski/ 한국어/ Türkçe/ Русский/ Bahasa Indonesia/ العربية/ Tiếng Anh)
Blank Screen	Press the cursor ◀▶ button to select different color to blank the screen.
Projection	Press the cursor ◀▶ button to choose from four projection methods: Front, Rear, Ceiling, Rear + Ceiling
Aspect Ratio	Press the cursor ◀▶ button to adjust the video aspect ratio.
Keystone	Press the cursor ◀▶ button to adjust trapezoid images.
Digital Zoom	Press the cursor ◀▶ button to adjust the Digital Zoom.
Advanced	Press ◀ (Enter) / ▶ to enter the Advanced menu. See <i>Advanced</i> on page 27.
Reset	Press ◀ (Enter) / ▶ to reset all Installation1 settings to default values (expect Language and Security Lock).

Advanced

Press ◀ (Enter) / ▶ to enter the **Advanced** sub menu.

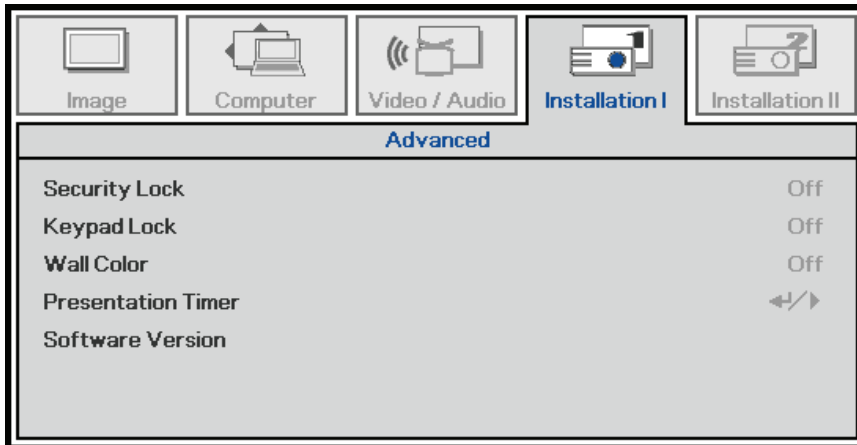

ITEM	DESCRIPTION
Security Lock	Press the cursor ◀▶ button to enable or disable the security lock function.
Keypad Lock	Press the cursor ◀▶ button to enable or disable the keypad lock function.
Wall Color	When displaying the image against a wall, press the cursor ◀▶ button to select different wall color settings. This will help compensate for color variations caused by the wall surface.
Presentation Timer	Press ◀ (Enter) / ▶ to enter the Presentation Timer menu. See <i>Presentation Timer</i> below
Software Version	Display the software version information.

*Presentation Timer*

Press ◀ (Enter) / ▶ to enter the **Presentation Timer** sub menu.

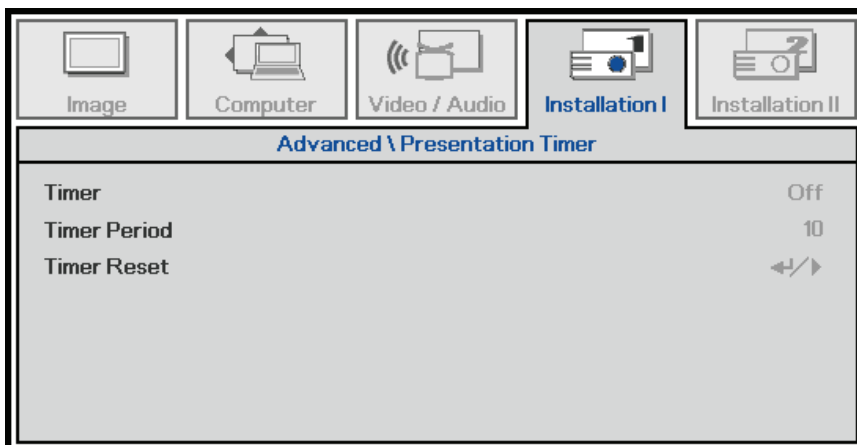

ITEM	DESCRIPTION
Timer	Press the cursor ◀▶ button to enable or disable the presentation timer function.
Timer Period	Press the cursor ◀▶ button to adjust the display timer period.
Timer Reset	Press ◀ (Enter) / ▶ to reset the presentation timer counter.

## Installation II Menu

Press the **MENU** button to open the **OSD** menu. Press the cursor ◀▶ button to move to the **Installation II** menu. Press the cursor ▲▼ button to move up and down in the Installation II menu.

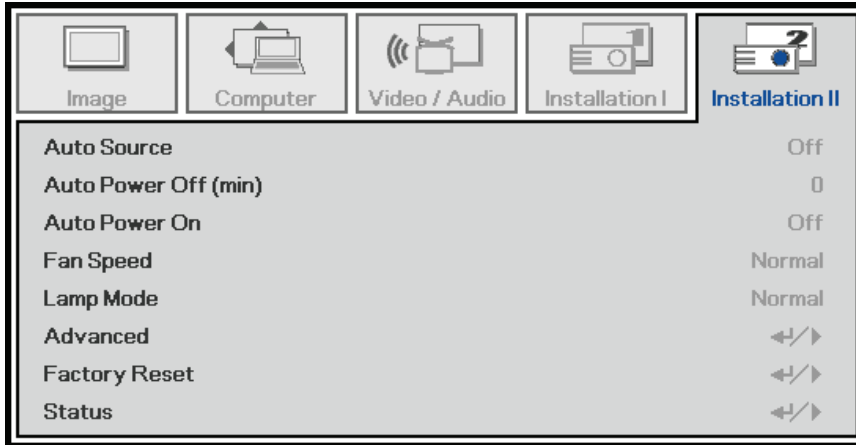

ITEM	DESCRIPTION																				
Auto Source	Press the cursor ◀▶ button to enable or disable automatic source detection.																				
Auto Power Off (min.)	Press the cursor ◀▶ button to enable or disable automatic shutdown of lamp when no signal.																				
Auto Power On	Press the cursor ◀▶ button to enable or disable Automatic Power On when AC power is supplied.																				
Fan Speed	<p>Press the cursor ◀▶ button to toggle between Normal and High fan speeds.  <b>Note:</b> We recommend selecting high speed in high temperatures, high altitude areas.</p> <table border="1"> <thead> <tr> <th></th> <th>≤ 25°C (77°F)</th> <th>26~30°C (78.8~86°F)</th> <th>31~35°C (87.8~95°F)</th> </tr> </thead> <tbody> <tr> <td>0~4,999ft (0~1523m)</td> <td colspan="3">Normal Mode</td> </tr> <tr> <td>5,000 ft (1524m)</td> <td>Normal Mode</td> <td colspan="2">High Speed Mode</td> </tr> <tr> <td>7,500 ft (2286m)</td> <td colspan="2">High Speed Mode</td> <td>-----</td> </tr> <tr> <td>10,000 ft (3048m)</td> <td>High Speed Mode</td> <td colspan="2">-----</td> </tr> </tbody> </table>		≤ 25°C (77°F)	26~30°C (78.8~86°F)	31~35°C (87.8~95°F)	0~4,999ft (0~1523m)	Normal Mode			5,000 ft (1524m)	Normal Mode	High Speed Mode		7,500 ft (2286m)	High Speed Mode		-----	10,000 ft (3048m)	High Speed Mode	-----	
	≤ 25°C (77°F)	26~30°C (78.8~86°F)	31~35°C (87.8~95°F)																		
0~4,999ft (0~1523m)	Normal Mode																				
5,000 ft (1524m)	Normal Mode	High Speed Mode																			
7,500 ft (2286m)	High Speed Mode		-----																		
10,000 ft (3048m)	High Speed Mode	-----																			
Lamp Mode	Press the cursor ◀▶ button to select the lamp mode for higher brightness (Normal) or lower brightness (Eco) to save lamp life.																				
Advanced	Press ◀ (Enter) / ▶ to enter the Advanced menu. See <i>Advanced Features</i> on page 29.																				
Factory Reset	Press ◀ (Enter) / ▶ to reset all OSD settings to factory default settings.																				
Status	Press ◀ (Enter) / ▶ to enter the Status menu. See page 31 for more information on <i>Status</i> .																				

### Advanced Features

Press the **Menu** button to open the **OSD** menu. Press ◀▶ to move to the **Installation II** menu. Press ▲▼ to move to the **Advanced** menu and then press **Enter** or ▶. Press ▲▼ to move up and down in the **Advanced** menu. Press ◀▶ to change setting values.

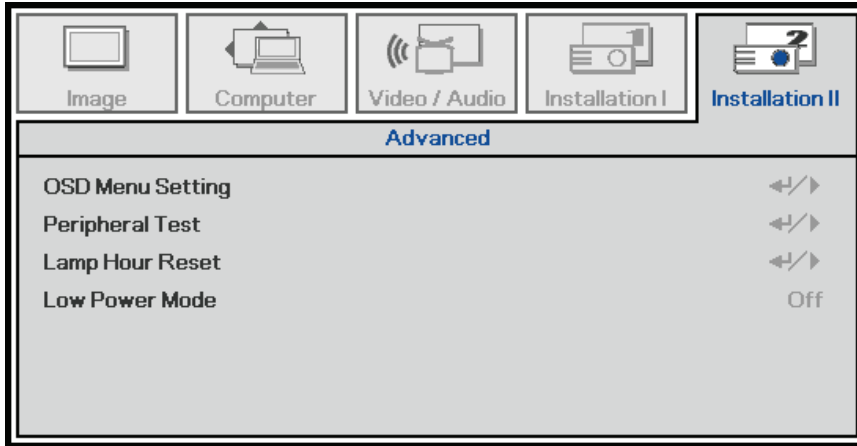

ITEM	DESCRIPTION
OSD Menu Setting	Press Enter / ▶ to enter the OSD setting menu. See page 30 for more information on <i>OSD Menu Setting</i> .
Peripheral Test	Press Enter/ ▶ to enter the Peripheral Test menu. See page 30 for more information on <i>Peripheral Test</i> .
Lamp Hour Reset	After replacing the lamp, this item should be reset. See page 31 for more information on <i>Lamp Hour Reset</i> .
Low Power Mode	Press ◀▶ to turn Low Power Mode on or off. This affects power consumption when the projector is in standby. When this feature is on, the projector will use less than 1 watt of electricity in standby mode. When this feature is off, the projector will use 9 watts of electricity in standby mode.

OSD Menu Setting

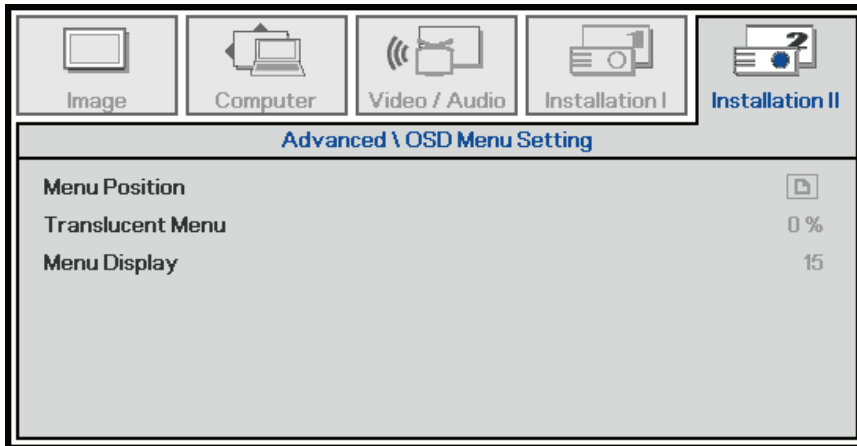

ITEM	DESCRIPTION
Menu Position	Press ◀▶ button to move the OSD menu position.
Translucent Menu	Press ◀▶ button to adjust the OSD opacity.
Menu Display	Press ◀▶ button to select the OSD timeout delay.

Peripheral Test

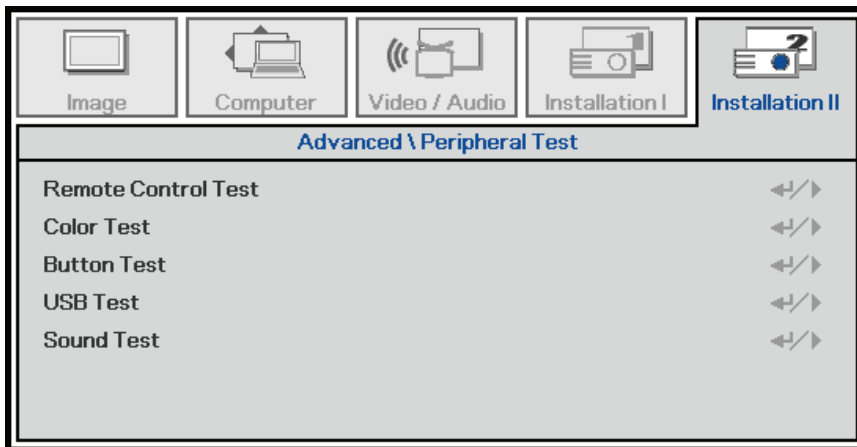

ITEM	DESCRIPTION
Remote Control Test	Press ◀ (Enter) / ▶ to test the IR remote control for diagnostic testing.
Color Test	Press ◀ (Enter) / ▶ to display colored test patterns.
Button Test	Press ◀ (Enter) / ▶ to test the keypad buttons.
USB Test	Press ◀ (Enter) / ▶ to test the USB connection with the connected PC.
Sound Test	Press ◀ (Enter) / ▶ to test the audio output.

*Lamp Hour Reset*

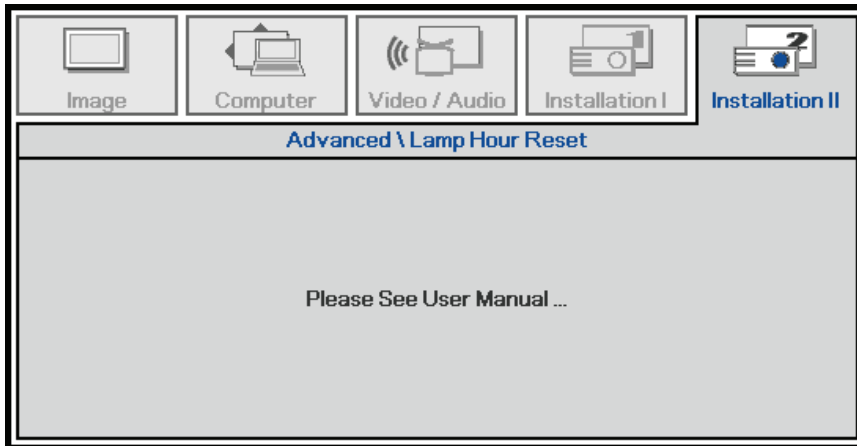

Please refer to *Replacing the Projection Lamp* on page 32 to reset the lamp hour counter.

Press ▼▲◀▶ buttons to reset the lamp hour

Status

Press the cursor ▲▼ button to move up and down in the **Installation II** menu. Select the **Installation II** sub menu and press ◀ (Enter) / ▶ to enter the **Status** sub menu.

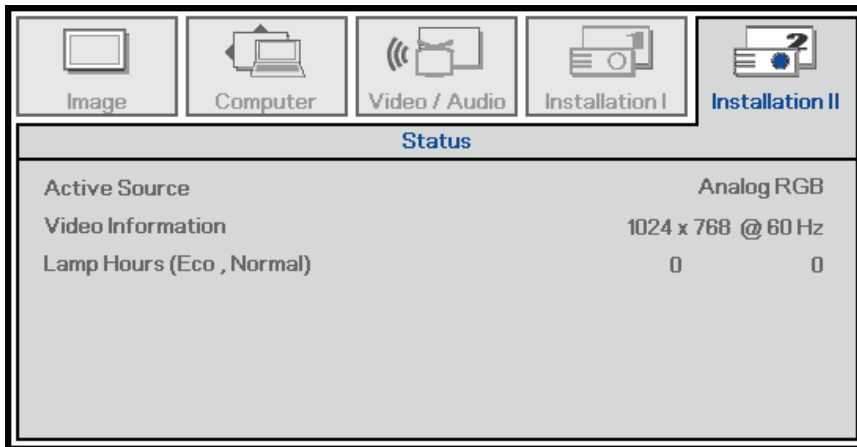

ITEM	DESCRIPTION
Active Source	Displays the active source.
Video Information	Displays resolution/video information for RGB source and color standard for Video source.
Lamp Hours	Displays the number of hours the lamp has been used in Eco and Normal modes.

## Replacing the Projection Lamp

Be sure to use the InFocus lamp module designed for this projector. You can order new lamps from [www.infocusstore.com](http://www.infocusstore.com) (in select areas), your retailer or your dealer. Only genuine InFocus lamps are tested for use in this projector. Use of non InFocus lamps may cause electrical shock and fire, and may void the projector warranty. InFocus is not liable for the performance, safety or certification of any other lamps.

**Warning:**

- *The projector uses a high-pressure mercury glass lamp. The lamp may fail prematurely, or it may rupture with a popping sound if jolted, scratched, or handled while hot. The risk of lamp failure or rupture also increases as the lamp age increases.*
- *Do not touch or block the projector lens with any objects as this can damage the projector lens. Scratches, gouges and other lens damage are not covered by the product warranty.*
- *Unplug the power cord before replacing the lamp.*
- *Do not drop the lamp module. The glass may shatter and cause injury.*
- *Do not touch the glass surface of the lamp module. Fingerprints can obscure projection sharpness and may cause the glass to shatter.*
- *Be extremely careful when removing the lamp housing. In the unlikely event that the lamp ruptures, small glass fragments may be generated. The lamp module is designed to contain most of these fragments, but use caution when removing it.*
- *Before replacing a ruptured lamp, clean the lamp compartment and dispose of cleaning materials. Wash hands after lamp replacement.*
- *When replacing the lamp while the projector is ceiling-mounted, wear protective eye-wear to prevent eye injury.*
- *Hg – Lamp contains mercury. Manage in accordance with local disposal laws. See [www.lamprecycle.org](http://www.lamprecycle.org).*
- *Be sure to turn off and unplug the projector at least 60 minutes before replacing the lamp. Failure to do so could result in a severe burn.*

1. Wait 60 minutes for the lamp to cool before attempting to replace lamp. Then loosen the two captive screws on the lamp compartment cover (A).
2. Remove the lamp compartment cover (B).

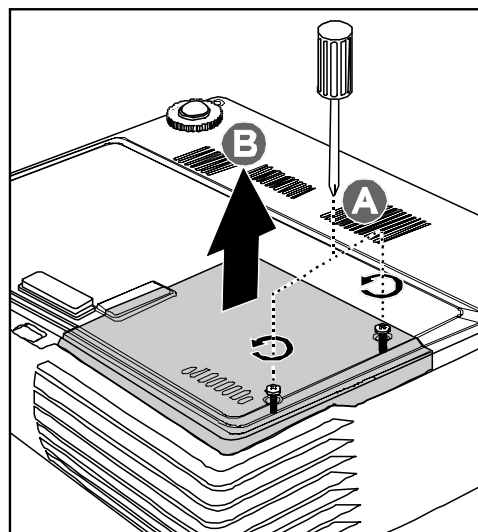

- 3.** Remove the two screws from the lamp module (A).

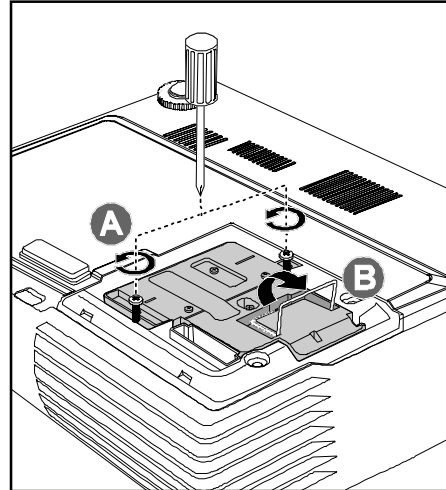

- 4.** Lift the module handle up (B).

- 5.** Pull firmly on the module handle to remove the lamp module.

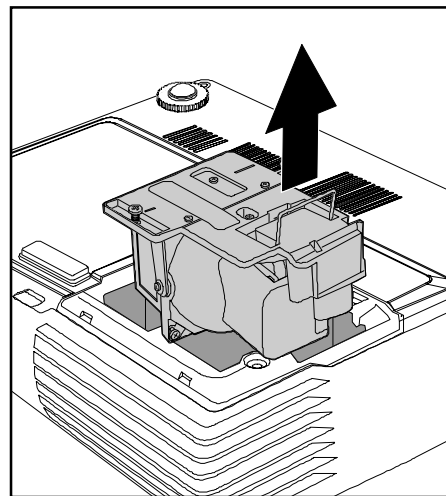

- 6.** Reverse steps 1 to 5 to install the new lamp module. While installing, align the lamp module with the connector and ensure it is level to avoid damage.

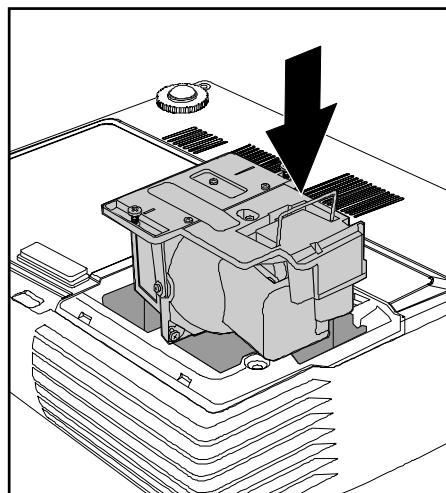

**Note:**

*The lamp module must sit securely in place and the lamp connector must be connected properly before tightening the screws.*

- 7.** Turn on the projector and reset the lamp after the lamp module is replaced.

Lamp Reset:

Press **Menu** → Select **Installation II / Advanced** → Select **Lamp Hour Reset** → Press the **▶** or **◀** buttons → Press **▼▲◀▶** buttons to reset the lamp hour.

Press the **MENU** button to get back to Installation II.



### Cleaning the Projector

Cleaning the projector to remove dust and grime will help ensure trouble-free operation.

**Warning:**

- 1. Be sure to turn off and unplug the projector at least 60 minutes before cleaning. Failure to do so could result in a severe burn.*
- 2. Use only a dampened cloth when cleaning. Do not allow water to enter the ventilation openings on the projector.*
- 3. If a little water gets into the projector interior while cleaning, leave unplugged in a well-ventilated room for several hours before using.*
- 4. If a lot of water gets into the projector interior when cleaning, have the projector serviced.*

#### Cleaning the Lens

You can purchase optic lens cleaner from most camera stores. Refer to the following to clean the projector lens.

1. Apply a little optic lens cleaner to a clean soft cloth. (Do not apply the cleaner directly to the lens.)
2. Lightly wipe the lens in a circular motion.

**Caution:**

- 1. Do not use abrasive cleaners or solvents.*
- 2. To prevent discoloration or fading, avoid getting cleaner on the projector case.*

#### Cleaning the Case

Refer to the following to clean the projector case.

1. Wipe off dust with a clean dampened cloth.
2. Moisten the cloth with warm water and mild detergent, and then wipe the case.
3. Rinse all detergent from the cloth and wipe the projector again.

**Caution:**

*To prevent discoloration or fading of the case, do not use abrasive alcohol-based cleaners.*

## Using the Security Lock

If you are concerned about security, attach the projector to a permanent object with the Security slot and a security cable.

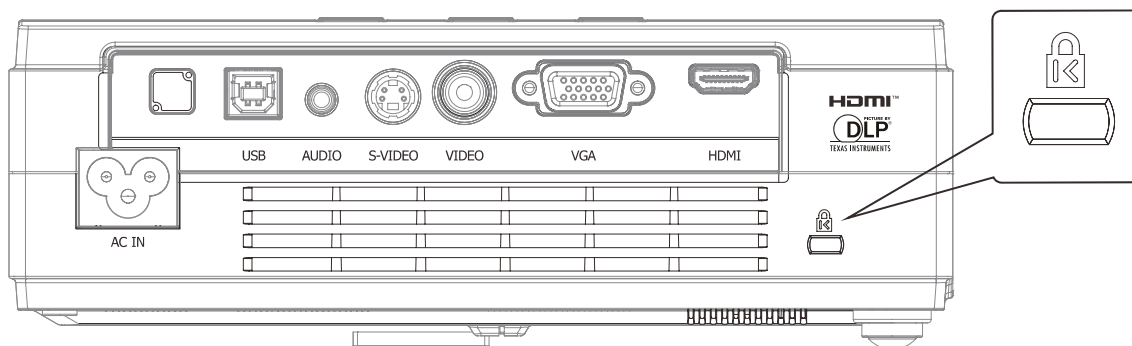

**Note:**  
Contact your vendor for details on purchasing a security cable.

## Common Problems and Solutions

These guidelines provide tips to deal with problems you may encounter while using the projector. If the problem remains unsolved, contact InFocus at [www.infocus.com/support](http://www.infocus.com/support).

Often the problem is traced to something as simple as a loose connection. Check the following before proceeding to problem-specific solutions.

- *Use another electrical device to confirm that the electrical outlet is working.*
- *Ensure the projector is turned on.*
- *Ensure all connections are securely attached.*
- *Ensure the attached device is turned on.*
- *Ensure a connected PC is not in standby mode.*
- *Ensure a connected notebook computer is configured for an external display. (This is usually done by pressing a Fn-key combination on the notebook.)*

## Tips for Troubleshooting

In each problem-specific section, try the steps in the order suggested. This may help you to solve the problem more quickly.

Try to pinpoint the problem and avoid replacing non-defective parts.

For example, if you replace battery and the problem remains, put the original battery back and go to the next step.

Keep a record of the steps you take when troubleshooting. The information may be useful when calling Technical Support and obtaining service.

## LED Error Messages

Error Code Messages	POWER LED	OVER TEMP LED	READY LED
Overheating	Off	Solid Red	Off
Thermal break status error	Flashing Green 4x	Off	Off
Lamp error	Flashing Green 5x	Off	Off
Fan1 error (Power Fan)	Flashing Green 6x	Off	Flashing Orange 1x
Fan2 error (Lamp Fan)	Flashing Green 6x	Off	Flashing Orange 2x
Fan3 error (Blower Fan)	Flashing Green 6x	Off	Flashing Orange 3x
Lamp door open	Flashing Green 7x	Off	Off
DMD error	Flashing Green 8x	Off	Off
Color wheel error	Flashing Green 9x	Off	Off

In the event of an error, please disconnect the AC power cord and wait for one (1) minute before re-starting the projector. If the POWER or READY LED is still blinking or the OVER TEMP LED is lit, contact InFocus Technical Support at [www.infocus.com/support](http://www.infocus.com/support).

## Image Problems

### ***Problem: No image appears on the screen***

1. Verify the settings on your notebook or desktop PC.
2. Turn off all equipment and power up again in the correct order.
3. Many laptops do not automatically turn on their external video port when a projector is connected. Usually a key combination like **FN + F8** or CRT/LCD key turns the external display on and off. Locate a function key labeled CRT/LCD or function key with a monitor symbol. Press FN and the labeled function key simultaneously.

### ***Problem: The image is blurred***

1. Adjust the **Focus** on the projector.
2. Press the **Auto** button on the remote control or projector keypad.
3. Ensure the projector-to-screen distance is within the projection range. (Within 7m/23' for the standard lens; within 20m/66' for the long lens and within 3m/10' for the short lens).
4. Check that the projector lens is clean.

### ***Problem: The image is wider at the top or bottom (trapezoid effect)***

1. Position the projector so it is as perpendicular to the screen as possible.
2. Use the **Keystone** buttons on the remote control or projector to correct the problem.

### ***Problem: The image is reversed***

Check the **Projection** setting in the Installation1 menu of the OSD.

### ***Problem: The image is streaked***

1. Set the **Frequency** and **Tracking** settings on the **Computer** menu of the OSD to the default settings.
2. To ensure the problem is not caused by a connected PC’s video card, connect to another computer.

***Problem: The image is flat with no contrast***

Adjust the **Contrast** setting on the **Image** menu of the OSD.

***Problem: The color of the projected image does not match the source image.***

Adjust the **Color Temperature** and **Gamma** settings on the **Image** menu of the OSD.

## Lamp Problems

***Problem: There is no light from the projector***

1. Check that the power cable is securely connected.
2. Ensure the power source is good by testing with another electrical device.
3. Restart the projector in the correct order and check that the Power LED is solid green.
4. If you have replaced the lamp recently, try resetting the lamp connections.
5. Replace the lamp module.
6. Put the old lamp back in the projector and have the projector serviced.

***Problem: The lamp goes off***

1. Power surges can cause the lamp to turn off. Unplug and re-plug the power cord and press the Power button.
2. If the lamp still does not ignite, unplug the projector and allow it to cool for 60 minutes. Replace the lamp.
3. If a new lamp does not resolve the issue, put the old lamp back into the projector and arrange to have the projector repaired.

## Remote Control Problems

***Problem: The projector does not respond to the remote control***

1. Direct the remote control towards remote sensor on the projector.
2. Ensure the path between remote and sensor is not obstructed.
3. Turn off any fluorescent lights in the room.
4. Check the battery polarity.
5. Replace the battery.
6. Turn off other infrared-enabled devices in the vicinity.
7. Replace the remote control.

## Audio Problems

### ***Problem: There is no sound***

1. Adjust the volume with the remote control.
2. Adjust the volume of the audio source.
3. Check the audio cable connection.
4. Disconnect audio out cable.
5. Test the source audio output with other speakers.
6. Have the projector serviced.

### ***Problem: The sound is distorted***

1. Check the audio cable connection.
2. Test the source audio output with other speakers.
3. Have the projector serviced.

## Having the Projector Serviced

If you are unable to solve the problem contact InFocus Technical Support at [www.infocus.com/support](http://www.infocus.com/support). If your projector needs repair, pack the projector in the original carton and include the return authorization number on the outside of the box.

### HDMI Q & A

***Q. What is the difference between a “Standard” HDMI cable and a “High-Speed” HDMI cable?***

Recently, HDMI Licensing, LLC announced that cables would be tested as Standard or High-Speed cables.

Standard (or “category 1”) HDMI cables have been tested to perform at speeds of 75Mhz or up to 2.25Gbps, which is the equivalent of a 720p/1080i signal.

High Speed (or “category 2”) HDMI cables have been tested to perform at speeds of 340Mhz or up to 10.2Gbps, which is the highest bandwidth currently available over an HDMI cable and can successfully handle 1080p signals including those at increased color depths and/or increased refresh rates from the Source. High-Speed cables are also able to accommodate higher resolution displays, such as WQXGA cinema monitors (resolution of 2560 x 1600).

***Q. How do I run HDMI cables longer than 10 meters?***

There are many HDMI Adopters working on HDMI solutions that extend a cable’s effective distance from the typical 10 meter range to much longer lengths. These companies manufacture a variety of solutions that include active cables (active electronics built into cables that boost and extend the cable’s signal), repeaters, amplifiers as well as CAT5/6 and fiber solutions.

***Q. How can I tell if a cable is an HDMI certified cable?***

All HDMI products are required to be certified by the manufacturer as part of the HDMI Compliance Test Specification. However, there may be instances where cables bearing the HDMI logo are available but have not been properly tested. HDMI Licensing, LLC actively investigates these instances to ensure that the HDMI trademark is properly used in the market. We recommend that consumers buy their cables from a reputable source and a company that is trusted.

For more detailed information, go to: <http://www.hdmi.org/learningcenter/faq.aspx#49>

## SPECIFICATIONS

### Specifications

Model	IN1124	IN1126
Display type	XGA 0.55"	WXGA 0.65"
Native Resolution	1024x768	1280x800
Projection distance (standard lens)	1.5 meters ~ 10 meters ( 4.92 ft ~ 32.81 ft )	
Projection screen size (standard lens)	27" ~ 207" ( 68.58cm ~ 525.78cm )	34" ~ 257" ( 86.36cm ~ 652.78cm )
Projection lens	Manual Focus/Manual Zoom	
Zoom ratio (standard lens)	1.15x	
Vertical keystone correction	+/- 15 degrees	
Projection methods	Front, Rear, Desktop/Ceiling (Rear, Front)	
Data compatibility	VGA, SVGA, XGA, SXGA, SXGA+, UXGA, Mac	
SDTV/ EDTV/ HDTV	480i, 480p, 576i, 576p, 720p, 1080i, 1080p	
Video compatibility	NTSC 4.43, PAL (M/N/60), SECAM	
H-Sync	15K, 30 – 91.4 KHz	
V-Sync	43 – 87 Hz	
Safety certification	FCC-B, UL, cUL, CB, CE, CCC, PCT, PSB, SABS, NOM, CECP, SASO, Tuv-GS, KC, UL-s for Argentina and C-TICK	
Operation temperature	5° ~ 35°C ( 41° ~ 95°F)	
Dimensions (W x D x H)	220.00mm x 178.00mm x 71.00mm (8.66" x 7.01" x 2.80")	
AC Input	AC Universal 100-240, Typical @ 110VAC (100-240)/± 10%	
Power consumption	Normal mode: 280W / ECO mode: 230W	
Standby	<1 W	
Lamp	Normal mode: 220W / ECO mode: 176W	
Audio speaker	1W mono speaker	
Input Terminals	VGA x 1	
	S-Video x 1	
	Composite video x 1	
	HDMI x 1	
Control Terminals	PC audio jack x 1	
	USB (type B)	
Security	Security cable lock slot	



### Projection Distance vs. Projection Size

For XGA

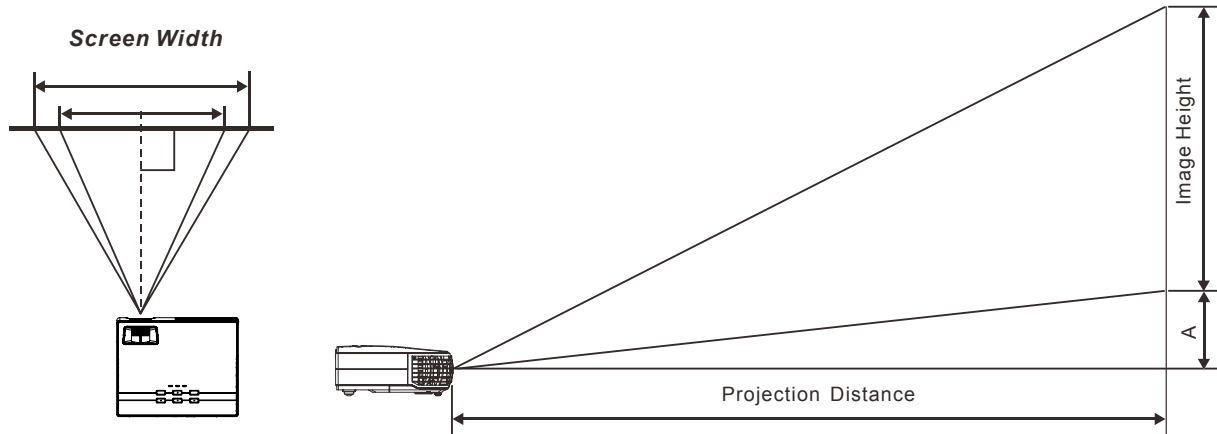

Projection Distance and Size Table

IN1124	TELE				WIDE			
Distance (m/inch)	1.56/ 61.42	4.47/ 175.98	7.15/ 281.5	9.83/ 387.01	1.54/ 60.63	3.86/ 151.97	7.72/ 303.94	11.58/ 455.91
Diagonal (cm/inch)	88.9/ 35	254/ 100	406.4/ 160	558.8/ 220	101.6/ 40	254/ 100	508/ 200	762/ 300
Image Height (cm/inch)	53.34/ 21	152.4/ 60	243.84/ 96	335.28/ 132	60.96/ 24	152.4/ 60	304.8/ 120	457.2/ 180
Image Width (cm/inch)	71.12/ 28	203.2/ 80	325.12/ 128	447.04/ 176	81.28/ 32	203.2/ 80	406.4/ 160	606.9/ 238.94
A (cm/inch)	7.4/ 2.91	21.2/ 8.35	33.9/ 13.35	46.6/ 18.35	8.5/ 3.35	21.2/ 8.35	42.4/ 16.69	63.6/ 25.04
IN1126	TELE				WIDE			
Distance (m/inch)	1.52/ 59.84	4.55/ 179.13	7.58/ 298.43	9.86/ 388.19	1.65/ 64.96	3.3/ 129.92	6.59/ 259.45	9.89/ 389.37
Diagonal (cm/inch)	101.6/ 40	304.8/ 120	508/ 200	660.4/ 260	127/ 50	254/ 100	508/ 200	762/ 300
Image Height (cm/inch)	53.85/ 21.2	161.54/ 63.6	269.24/ 106	350.01/ 137.8	67.31/ 26.5	134.62/ 53	269.24/ 106	403.86/ 159
Image Width (cm/inch)	86.16/ 33.92	258.47/ 101.76	430.78/ 169.6	560.02/ 220.48	107.7/ 42.4	215.39/ 84.8	430.78/ 169.6	646.17/ 254.4
A (cm/inch)	6.1/ 2.4	18.3/ 7.2	30.6/ 12.05	39.7/ 15.63	7.6/ 2.99	15.3/ 6.02	30.6/ 12.05	45.8/ 18.03

## Timing Mode Table

The projector can display several resolutions. The following table outlines the resolutions that can be displayed by the projector.

SIGNAL	RESOLUTION	H-SYNC (KHz)	V-SYNC (Hz)	COMPOSITE / S-VIDEO	VGA (ANALOG)	HDMI (DIGITAL)
NTSC	—	15.734	60.0	○	—	—
PAL/SECAM	—	15.625	50.0	○	—	—
VESA	720 x 400	37.9	85.0	—	○	○
	640 x 480	31.5	60.0	—	○	○
	640 x 480	37.9	72.8	—	○	○
	640 x 480	37.5	75.0	—	○	○
	640 x 480	43.3	85.0	—	○	○
	800 x 600	35.2	56.3	—	○	○
	800 x 600	37.9	60.3	—	○	○
	800 x 600	46.9	75.0	—	○	○
	800 x 600	48.1	72.2	—	○	○
	800 x 600	53.7	85.1	—	○	○
	1024 x 600	37.3	60.0	—	○	○
	1024 x 768	48.4	60.0	—	○	○
	1024 x 768	56.5	70.1	—	○	○
	1024 x 768	60.0	75.0	—	○	○
	1024 x 768	68.7	85.0	—	○	○
	1280 x 720	45.0	60.0	—	○	○
	1280 x 720	90.0	120.0	—	○	○
	1280 x 800	49.7	59.8	—	○	○
	1280 x 800	62.8	74.9	—	○	○
	1280 x 800	71.6	84.8	—	○	○
	1280 x 1024	64.0	60.0	—	○	○
	1280 x 1024	80.0	75.0	—	○	○
	1280 x 1024	91.1	85.0	—	○	○
	1280 x 960	60.0	60.0	—	○	○
	1280 x 960	85.9	85.0	—	○	○
	1400 x 1050	65.3	60.0	—	○	○
	1440 x 900	70.6	75.0	—	○	○
	1440 x 900	55.9	60.0	—	○	○
	1600 x 1200	75.0	60	—	○	○
	Apple Macintosh	640 x 480	35.0	66.7	—	○
832 x 624		49.7	74.5	—	○	○
1024 x 768		60.2	74.9	—	○	○
1152 x 870		68.7	75.1	—	○	○

SIGNAL	RESOLUTION	H-SYNC (KHz)	V-SYNC (Hz)	COMPOSITE / S-VIDEO	VGA (ANALOG)	HDMI (DIGITAL)
SDTV	480i	15.734	60.0	○	*	—
	576i	15.625	50.0	○	*	—
EDTV	576p	31.3	50.0	○	*	○
	480p	31.5	60.0	○	*	○
HDTV	720p	37.5	50.0	○	*	○
	720p	45.0	60.0	○	*	○
	1080i	33.8	60.0	○	*	○
	1080i	28.1	50.0	○	*	○
	1080p	67.5	60.0	○	*	○
	1080p	56.3	50.0	○	*	○

○: Frequency supported

—: Frequency not supported

\*: VGA supports EDTV/SDTV/HDTV component sources using an adapter.

### Projector Dimensions

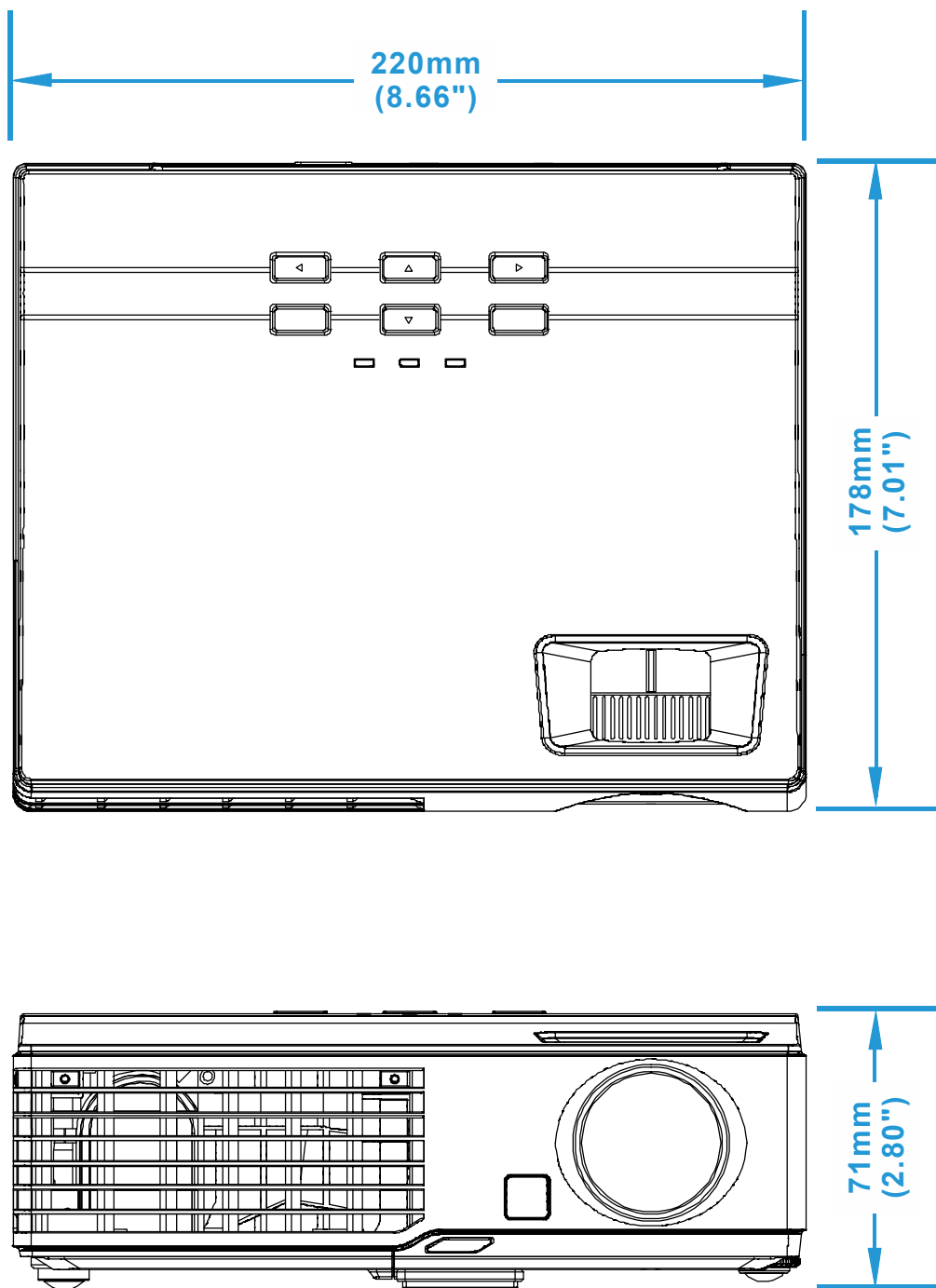

## FCC Warning

This equipment has been tested and found to comply with the limits for a Class B digital device pursuant to Part 15 of the FCC Rules. These limits are designed to provide reasonable protection against harmful interference when the equipment is operated in a commercial environment.

This equipment generates, uses, and can radiate radio frequency energy and, if not installed and used in accordance with the instruction manual, may cause harmful interference to radio communications. Operation of this equipment in a residential area is likely to cause harmful interference in which case the user will be required to correct the interference at his/her own expense.

Changes or modifications not expressly approved by the parties responsible for compliance could void the user's authority to operate the equipment.

## Canada

This class B digital apparatus complies with Canadian ICES-003.

## WEEE



**NOTE:** This product is covered electrical and electronic equipment under the European Union's Waste from Electrical and electronic Equipment ("WEEE") Directive (2002/96/EC). The WEEE Directive requires that covered equipment be collected and managed separately from typical household waste in all EU member states. Please follow the guidance of your local environmental authority or ask the shop where you purchased the product for collection or recycling options.

## Safety Certifications

FCC-B, UL, cUL, CB, CE, CCC, PCT, PSB, SABS, NOM, CECP, SASO, Tuv-GS, KC, UL-s for Argentina and C-TICK